

# Numerical simulation of the interaction between flow and flexible nets using a porous surface model

SARATH KRISHNAN KARUMATHIL

Laboratorio de Ingeniería Mecánica (LIM), University of A Coruña

Advisor : Manuel Jesús González Castro

Date : 13/12/2022



- **1. Introduction.**
- **2. Computational simulation of fishing nets.**
- **3. Surface based porous media model.**
- **4. Finding porous media resistance coefficients.**
- **5. Application : Sediment transport while demersal trawling.**
- **6. Conclusions and future works.**

- Fish as a food resource:

## Fisheries and Aquaculture.

- **Fisheries:** Capturing wild fish using different techniques.  
Over 53% of catch is from two type of fisheries  
**Demersal trawling** and **purse seine fishing**.

### Understanding fisheries for:

- Improving the selectivity.
- Reducing fuel consumption.
- Reducing seabed impact.
- Auditing fishing gears.

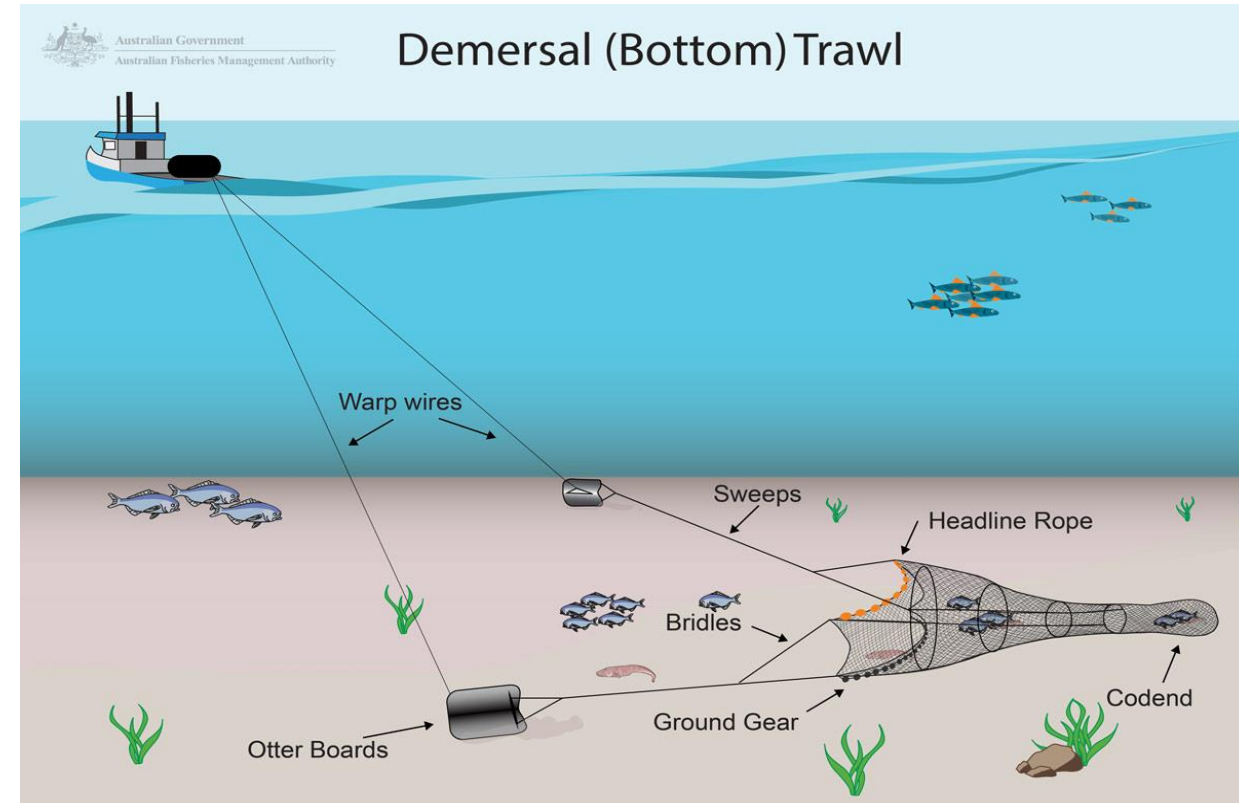

Source : [afma.gov.au](http://afma.gov.au)

- **Aquaculture:** Cultivating fish in net cages.
  - Has been practised since very old times around the world (Mainly inland).
  - Increased demand for fish: **Offshore cages**
  - Challenges and concerns:
    - Health of the fish in a cage depends on the Oxygen the water carries.
    - Biofouling of nets and their effect on the fish.
    - Flow through bigger farms containing many cages.

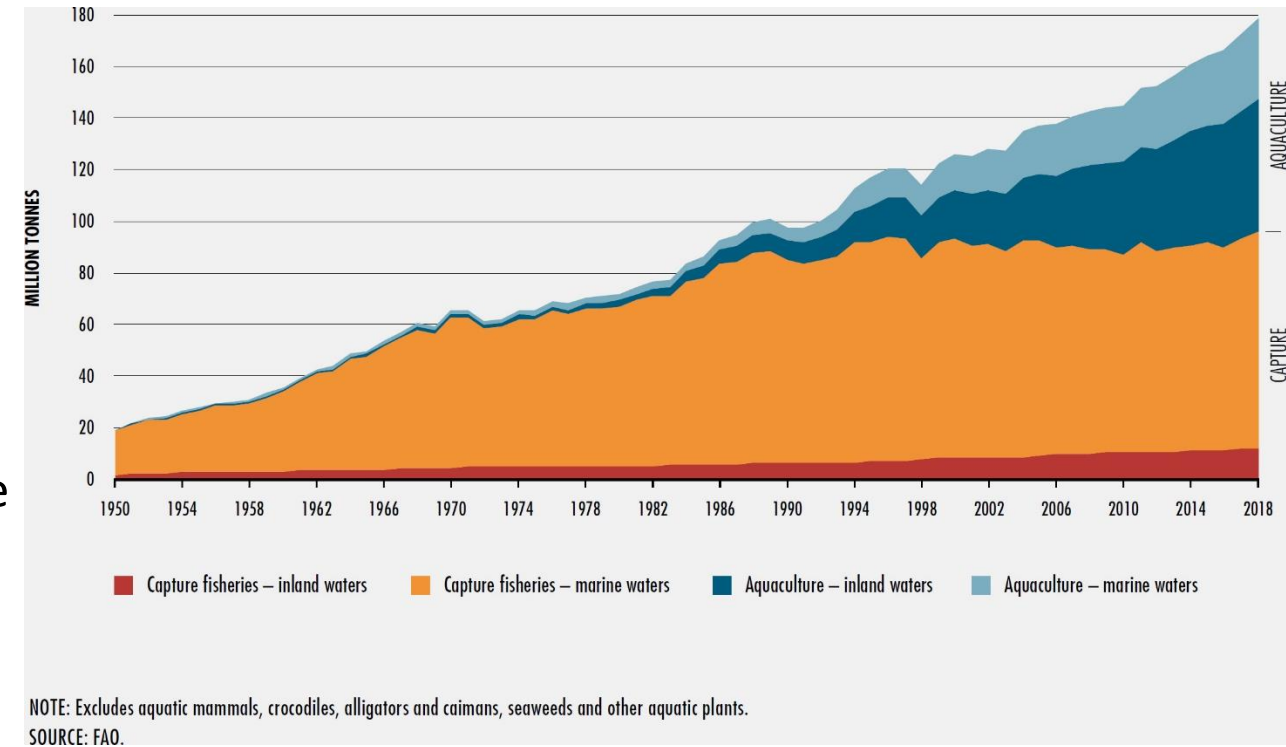

- Investigations on fishing nets in order to improve both industries.
  - Experimental and physical investigations.
    - Sea trails, Towing tank, Flume tank experiments.
    - Expensive and time consuming for even small improvements in the fishing gears.

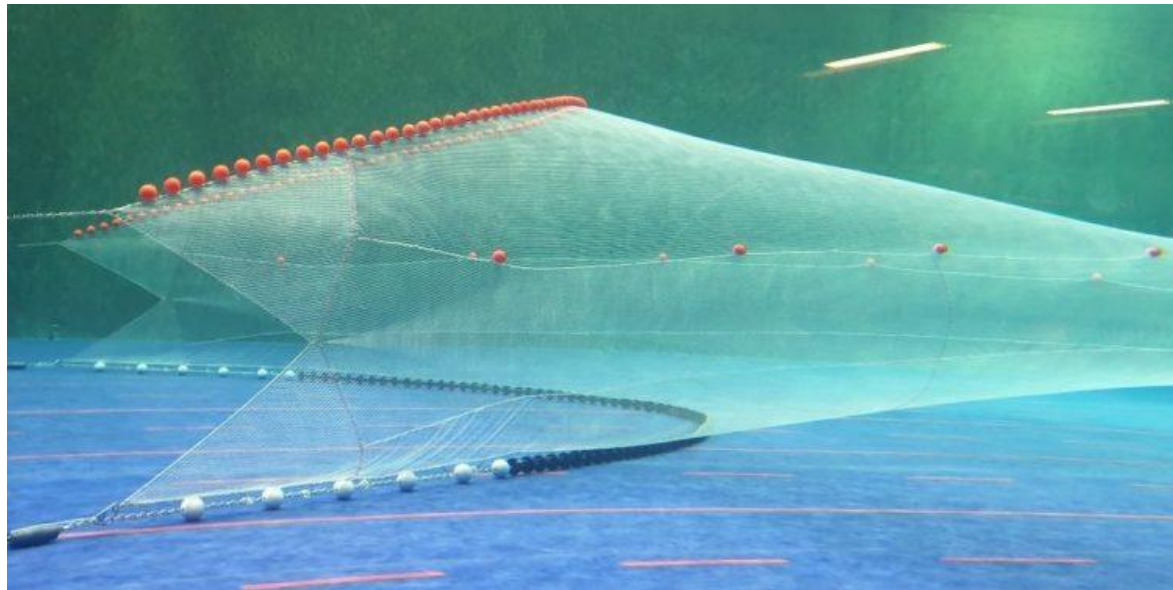

Source : fiskerforum.com



Towing tank : UDC

## Goals of this thesis:

- Computationally simulate fishing nets in a fluid domain.
- Investigate on the ways to find porous resistance coefficients.
- Validate the methods developed.
- Demonstrate the advantages and importance of the developed method.
- Apply in problems related with fisheries to understand influence of fishing nets and related parameters.

- Using **computational simulations** to understand and tackle problems found in Fisheries and Aquaculture.
- Fishing nets are flexible elements which deforms and moves with the fluid flow: A **Fluid Structure Interaction** problem.
- Structural solvers: Finite element models, Lumped mass models, etc.
- Difficulties in fluid simulation: Large nets with very small diameter resulting computationally expensive simulations.
- A porous media method as solution to simulate fluid part of the problem.  
Introduced by [Patursson et al 2010](#), [Zhao et al 2013](#).

Navier Stokes equations defining the flow:

$$\text{Continuity equation} \quad \nabla \cdot u = 0$$

$$\text{Momentum equation} \quad \nabla \cdot (u \otimes u) - \nabla \cdot R = -\nabla p + S_i$$

The source term is modelled using porous media models and is **Zero** outside the porous media.

$$\text{Darcy-Forchheimer porous media model:} \quad S_i = -(D_{ij}\mu u + \frac{1}{2}C_{ij}\rho|u|u)$$

Where  $D_{ij}$  is the material matrix with viscous resistance coefficients and  $C_{ij}$  with inertial resistance coefficients.



$$D_{ij} = \begin{pmatrix} D_1 & 0 & 0 \\ 0 & D_2 & 0 \\ 0 & 0 & D_3 \end{pmatrix} \quad C_{ij} = \begin{pmatrix} C_1 & 0 & 0 \\ 0 & C_2 & 0 \\ 0 & 0 & C_3 \end{pmatrix}$$

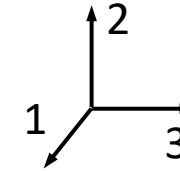

$D_i$  and  $C_i$  are defined in the local co-ordinate system of the porous media.

If out of alignment, local axes are **rotated** in order to align with the global axes of the fluid domain.

$$D_{ij} = \begin{pmatrix} D_n & 0 & 0 \\ 0 & D_t & 0 \\ 0 & 0 & D_t \end{pmatrix} \quad C_{ij} = \begin{pmatrix} C_n & 0 & 0 \\ 0 & C_t & 0 \\ 0 & 0 & C_t \end{pmatrix}$$

Porous resistance coefficients are inversely proportional to **thickness of porous media** for a given pressure drop: resulting easy modelling of porous media in fluid domain.

- Previous research modelled net as thin solids. (Patursson et al 2010, Chen and Christensen 2018)
- Treating net as a **Surface**.

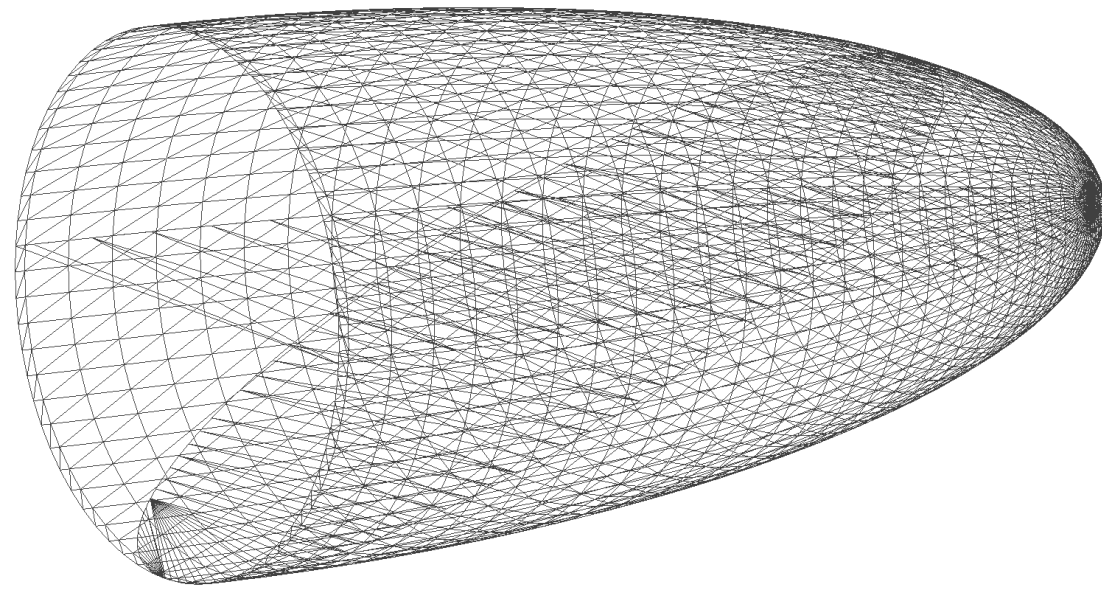
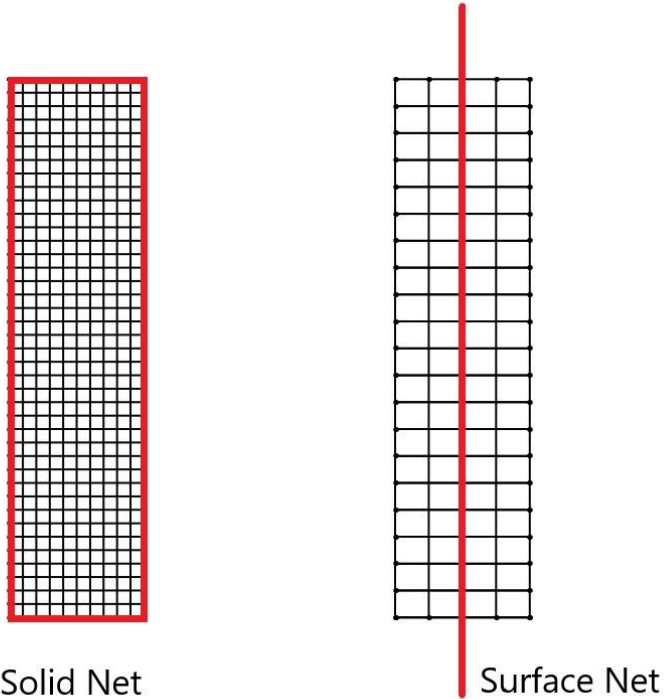

Modelling nets as **triangulated surfaces** and selecting the cells near to them for giving appropriate porous resistance.

MESHING NEAR THE SURFACES

SELECTING CELLS NEAR THE SURFACES

DEALING WITH MULTIPLE SURFACES

GROUPING TRIANGLE WITH SIMILAR  
ORIENTATION

GENERATING POROUS ZONES

### 3 Surface based porous media model : Meshing near the surfaces

MESHING

SELECTING CELLS

MULTIPLE  
SURFACES

GROUPING  
TRIANGLES

POROUS ZONES

A refined mesh next to the surface for achieving a good final porous media.

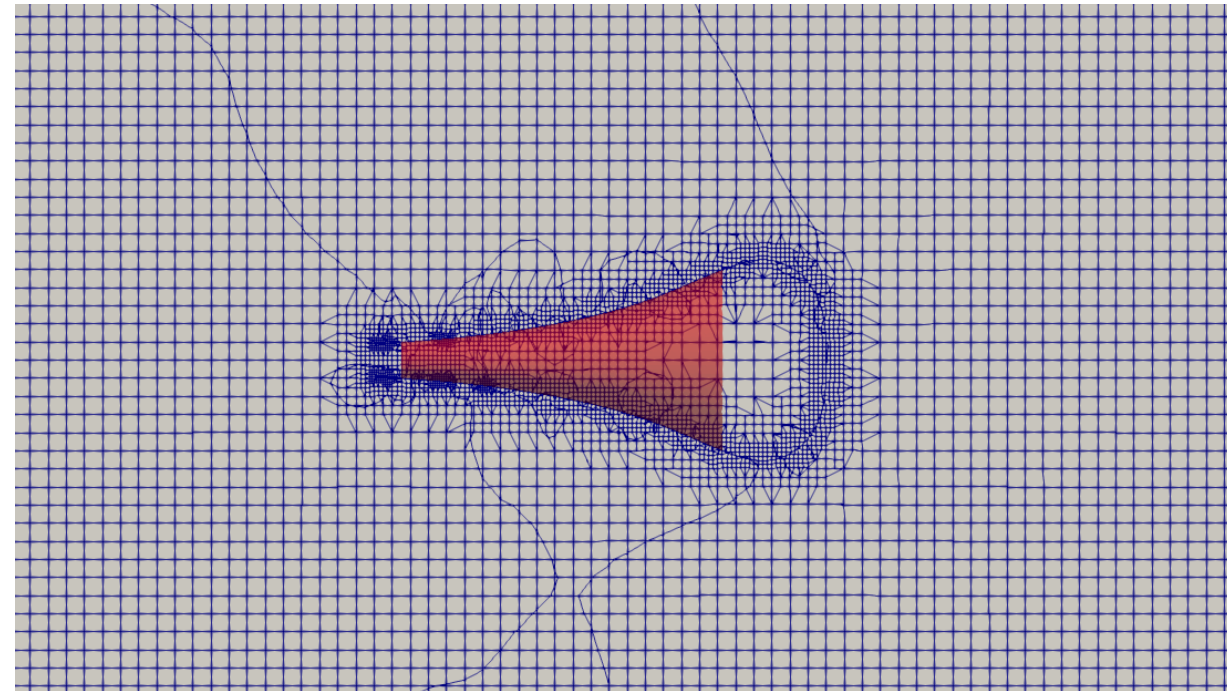
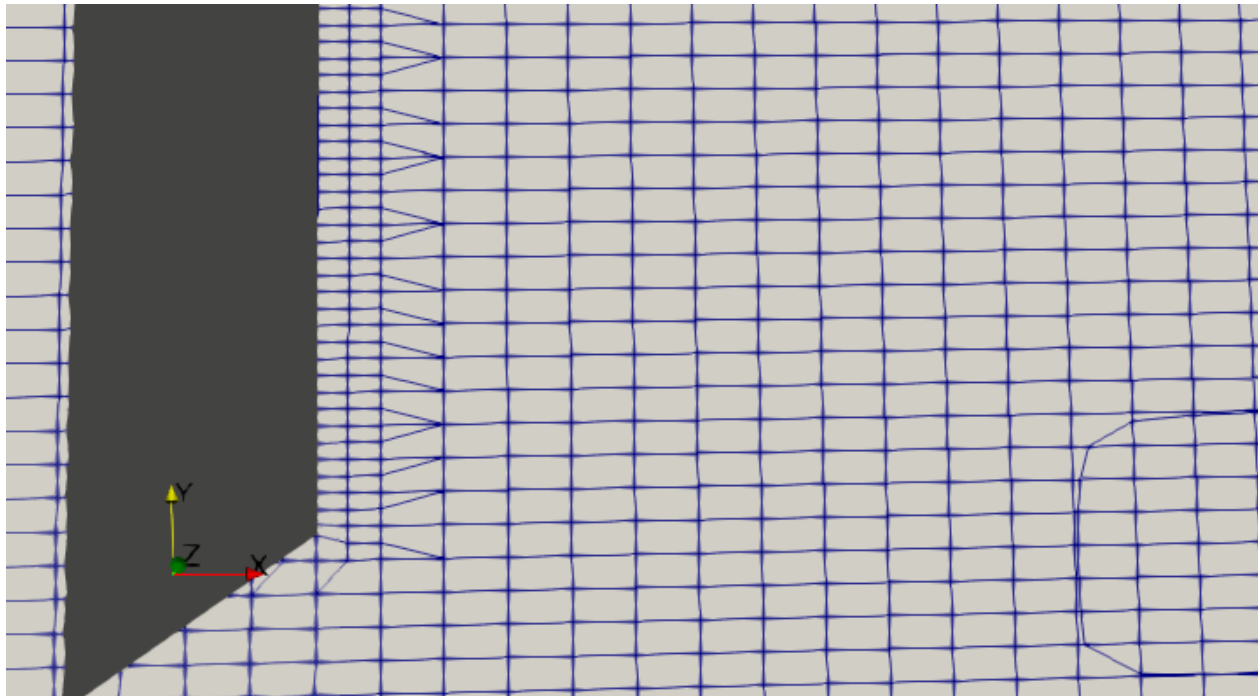

# 3 Surface based porous media model: Selecting cells near the surfaces



A cell  $C_i$  with distance to the Surface  $S_i$ ,  $d_i$  is included in the group if:

$$d_i < d_{max}$$
$$d_{max} = \text{Thickness}/2$$

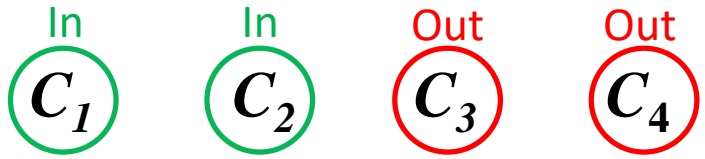

Cells outside the external edge of the Surface are not included. Eg.  $C_4$

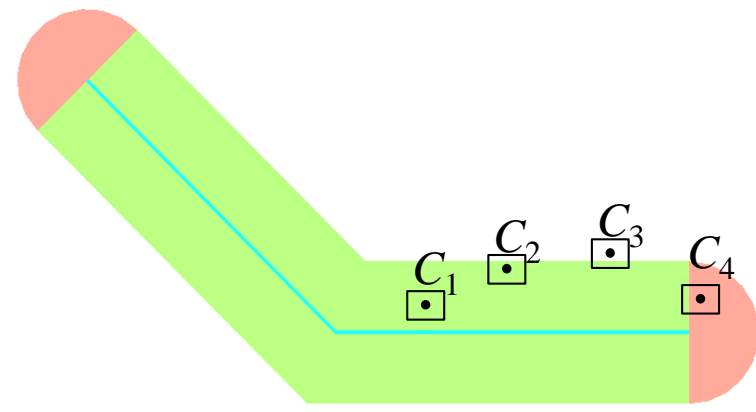
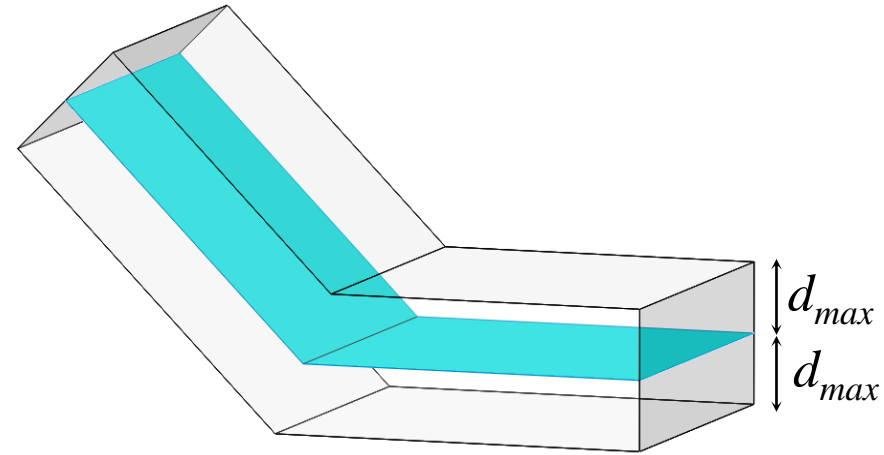

# 3 Surface based porous media model: Selecting cells near the surfaces

MESHING

SELECTING CELLS

MULTIPLE SURFACES

GROUPING TRIANGLES

POROUS ZONES

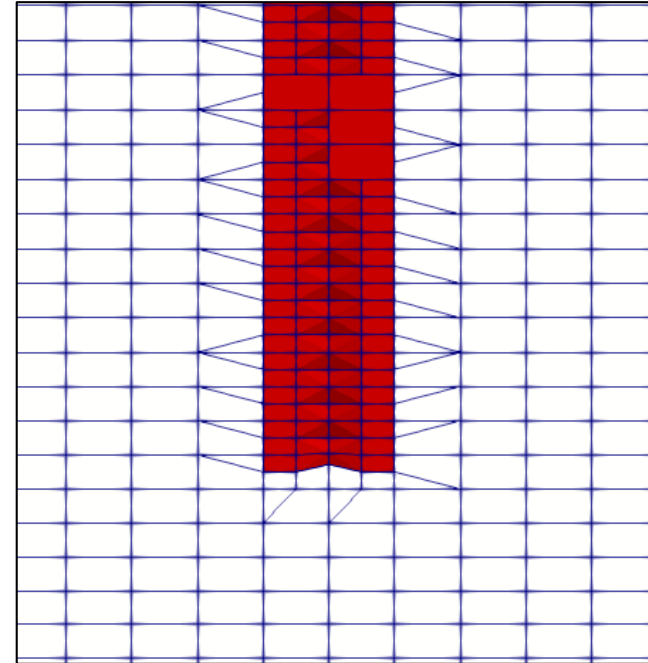
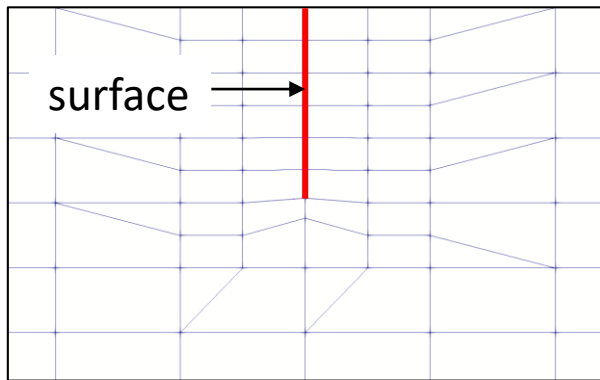
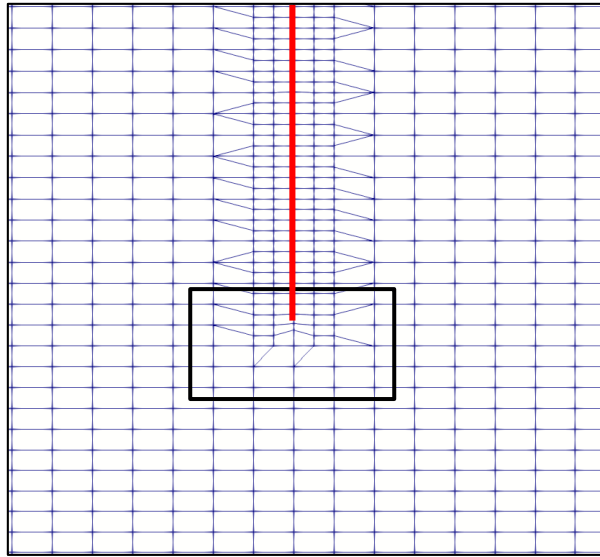



A fishing gear can have many different net panels.

Each net panel is treated as an independent triangulated surface.

$C_1$  &  $C_2$  are in the body of influence of both surfaces, yet could be included in only one group.

$C_3$  is not included in any of the groups.

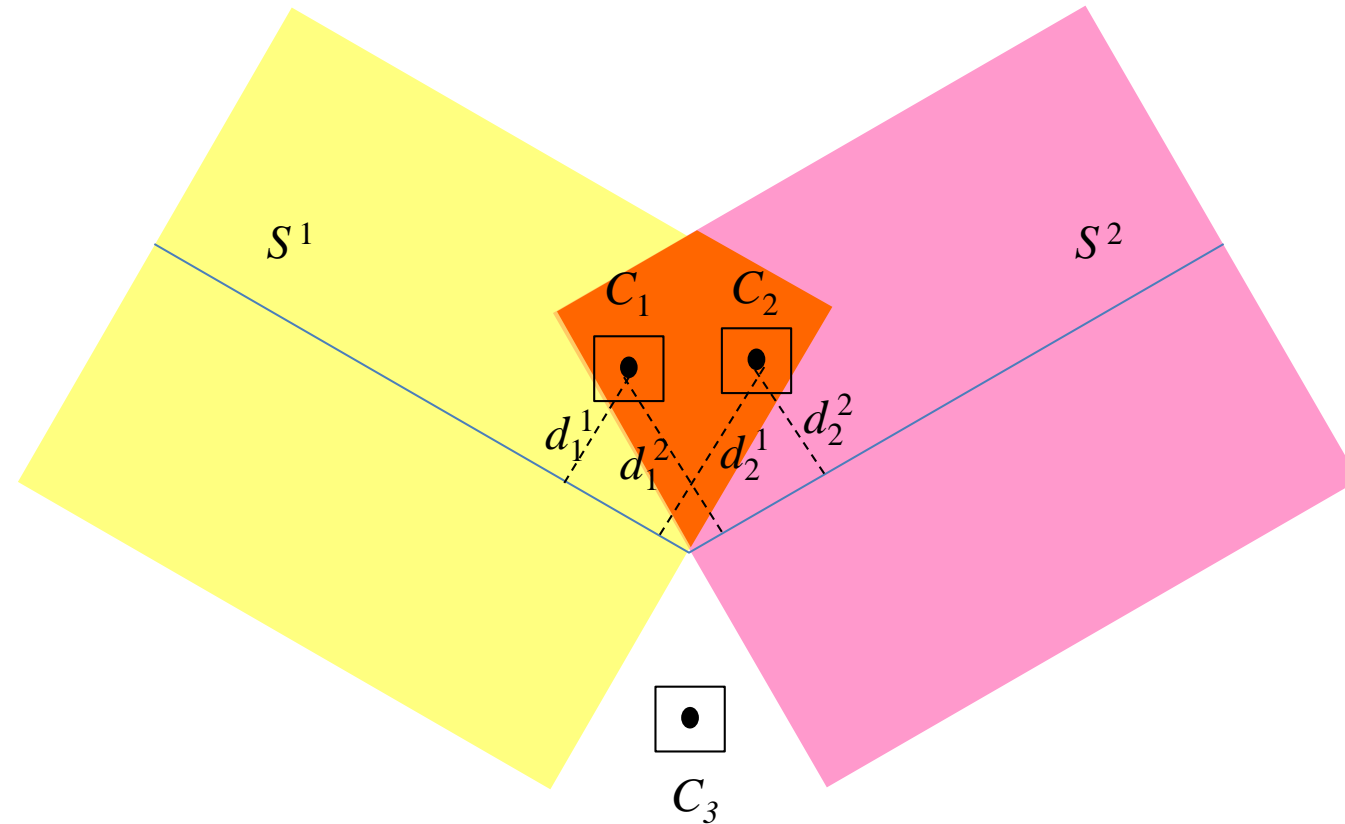



- Grouping cells according to the triangles.
- For curved net panels, a porous zone for each triangle with resistance matrices rotated according to orientation of the triangle.
- Surface triangles with similar orientation are grouped to create porous zones.
- A heuristic algorithm to group triangles according to a user-defined threshold angle

Surfaces can have many triangles!

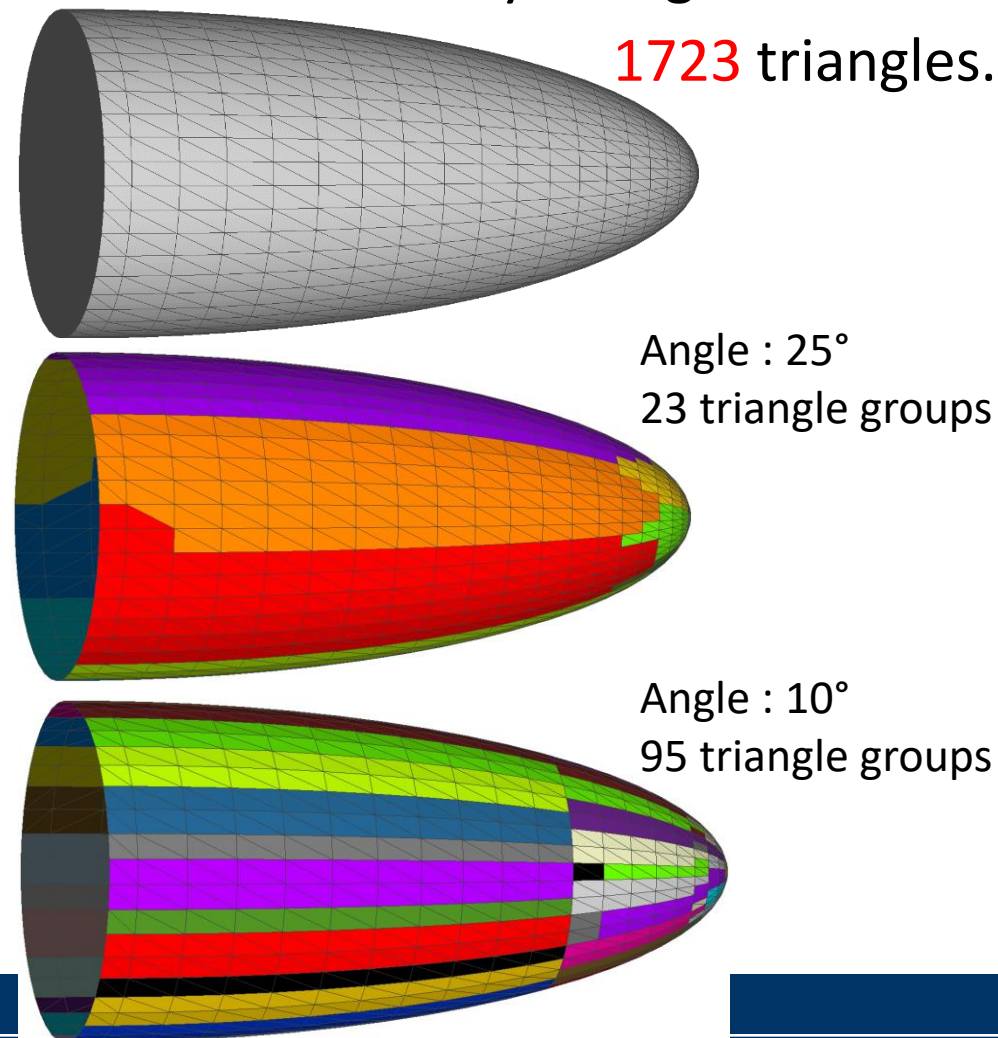



MESHING

SELECTING CELLS

MULTIPLE  
SURFACES

GROUPING  
TRIANGLES

POROUS ZONES

Each triangle group represent a porous zone.

Each cell  $C_i$  in the surface  $S_i$ , the closest triangle is found and cell is assigned to its triangle group.

The **average angle of orientation** and **average thickness** of the final porous media.

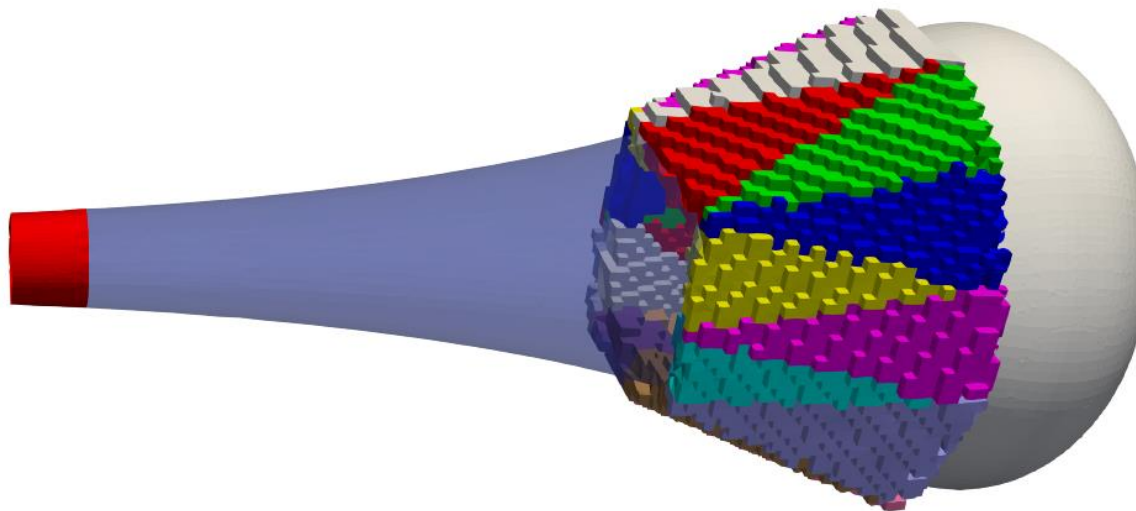

A square net panel towed at different angles and velocities

Parameters :

Velocity : (0.25, 0.5, 0.75 m/s)

Angle of attack : 0,15,30,45,60,75,90°

Solidity of the Net : 0.184

Porous resistance coefficient(\*) :

$D_n = 51730$ ,  $D_t = 26379$

$C_n = 5.098$   $C_t = 1.6984$

## Boundary conditions

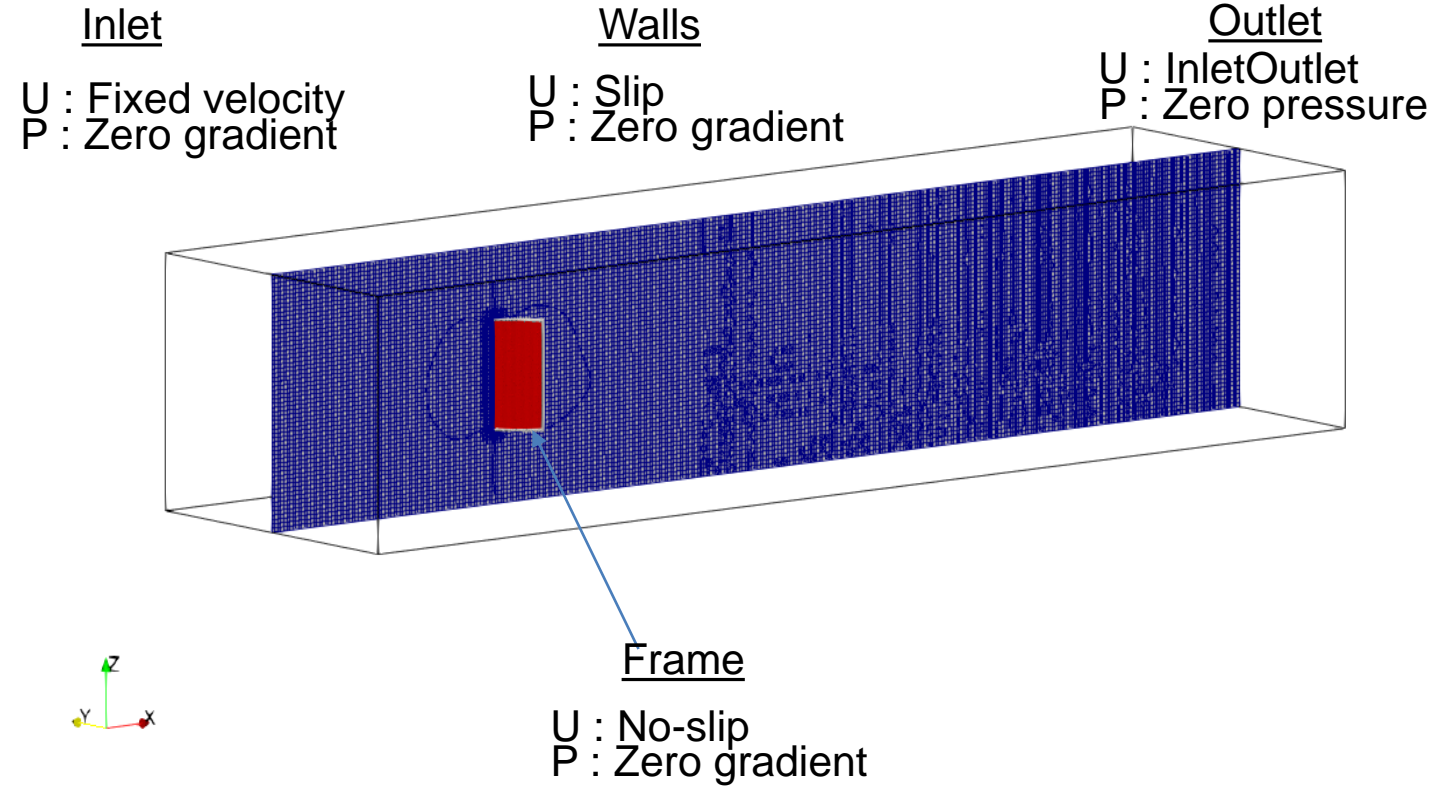

\* Given by Patursson et al. 2010

## Thickness of the porous media

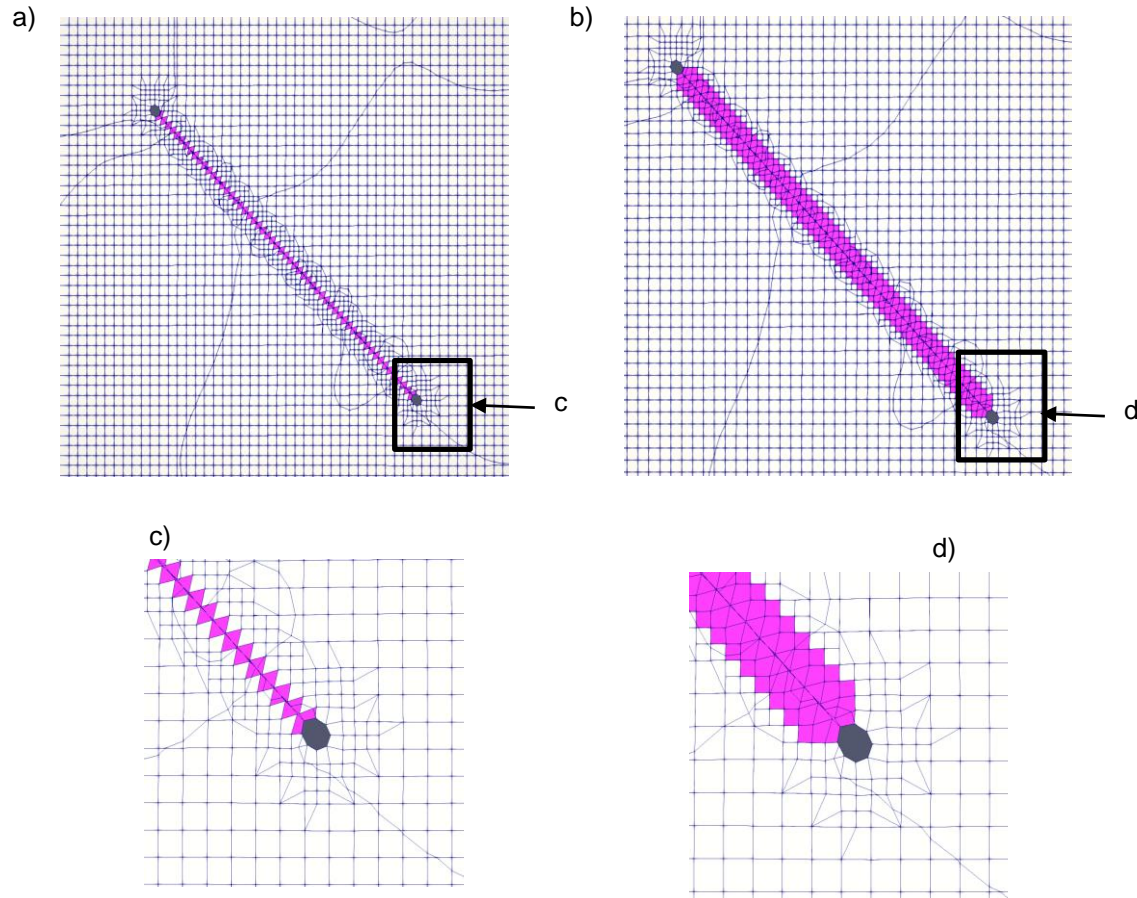

Thickness 20 mm

Thickness 60 mm

## Hydrodynamic coefficients

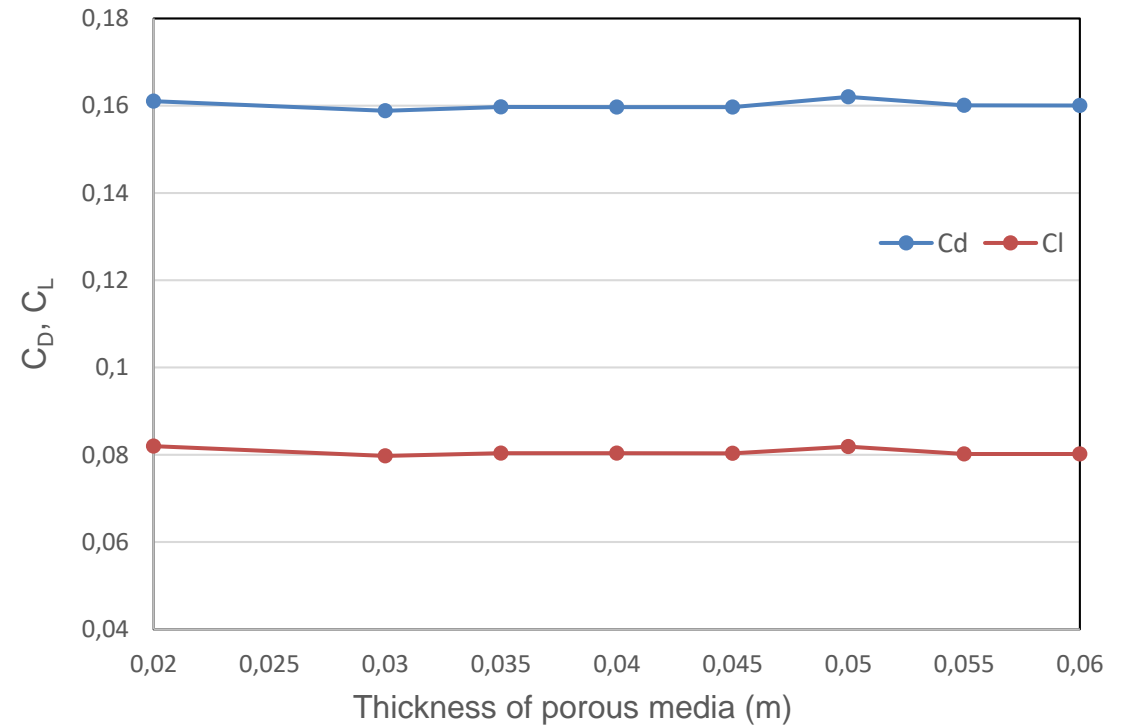

## Validation Vs Experimental results(\*)

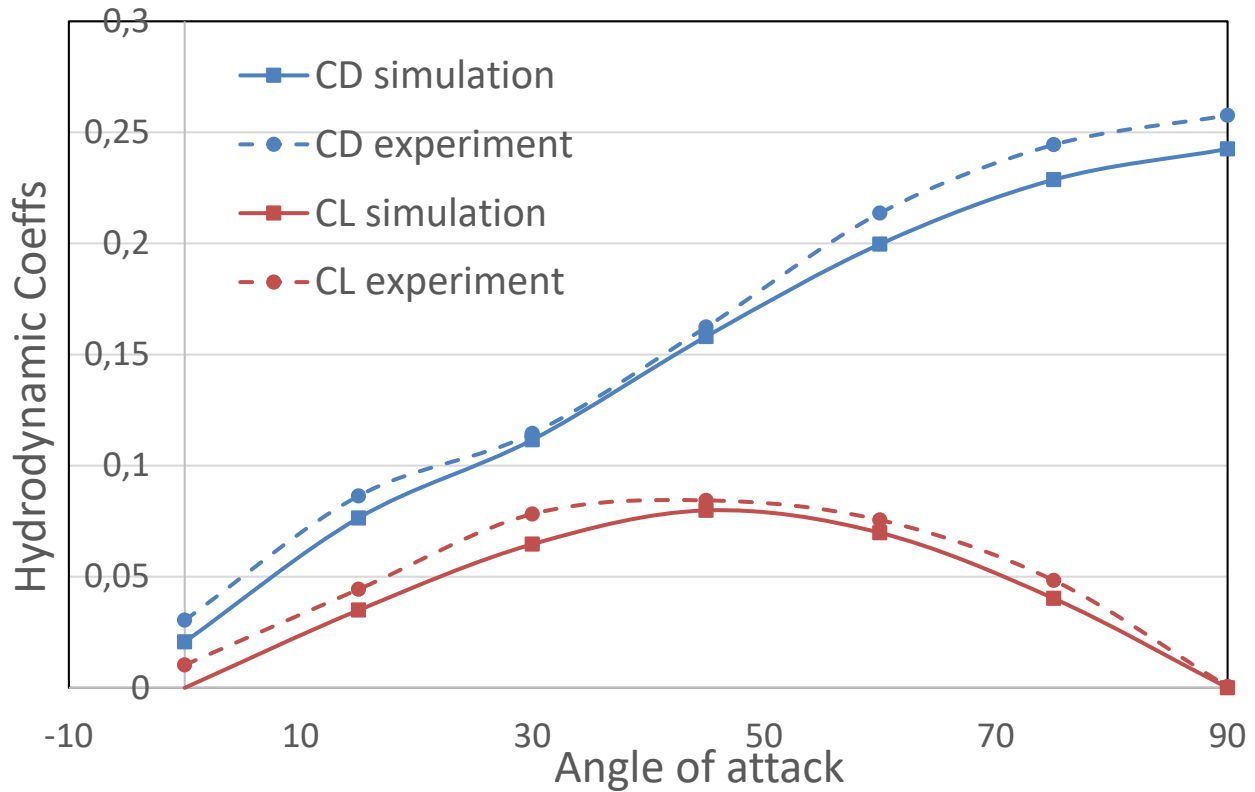

\* Experimental results from Patursson et al. 2010

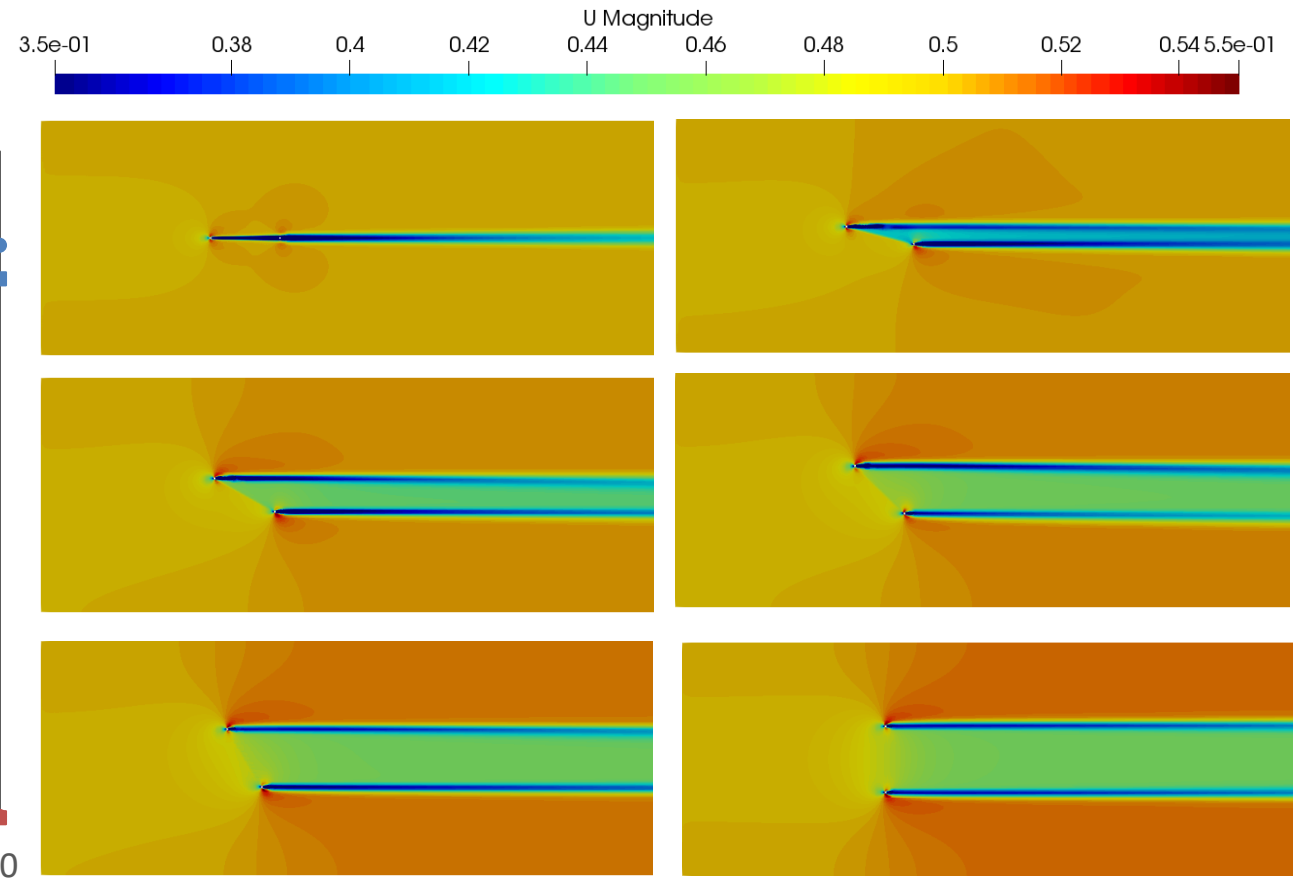

Velocity fields from CFD simulations at 0.5m/s angles of attack : 0,15,30,45,60,90°

- Demonstrate the need/advantage of modelling net as surfaces over thin solid.
- Fishing gears can have many different net panels with complex shapes.

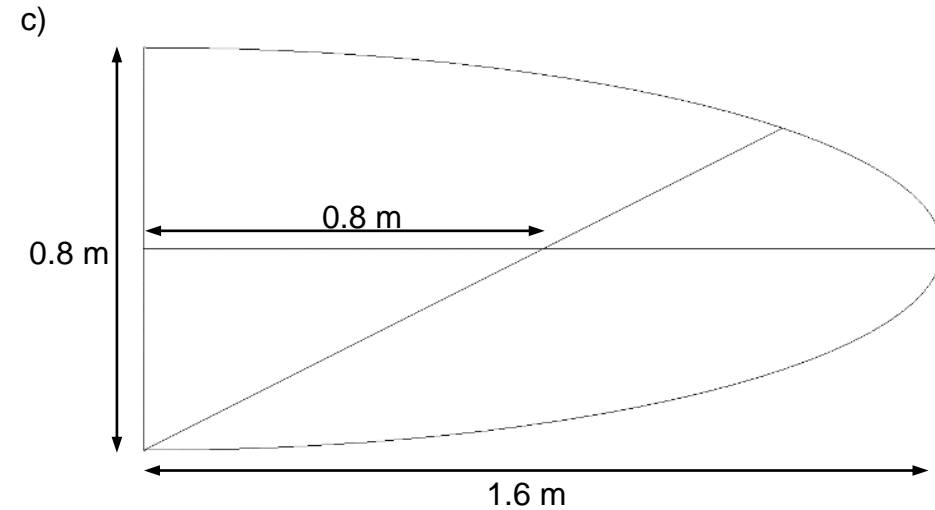
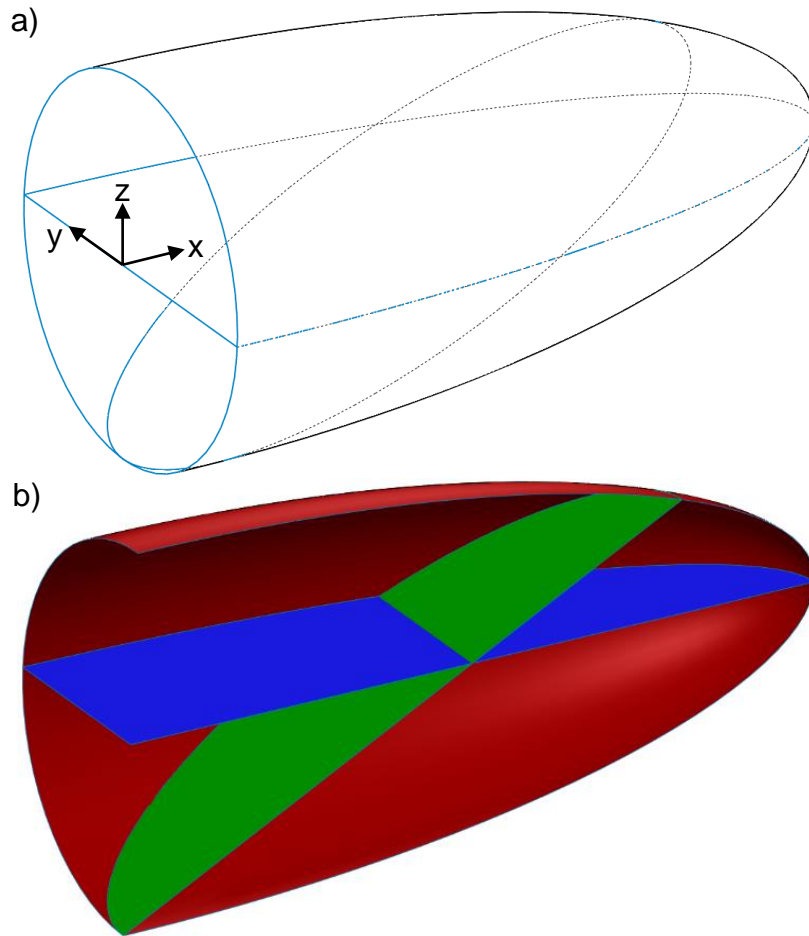

**Red net** : Same porous resistance coeffs as in Example 1  
**Blue net** : Half than the red one.  
**Green net** : Double than the red one

Thin solid method

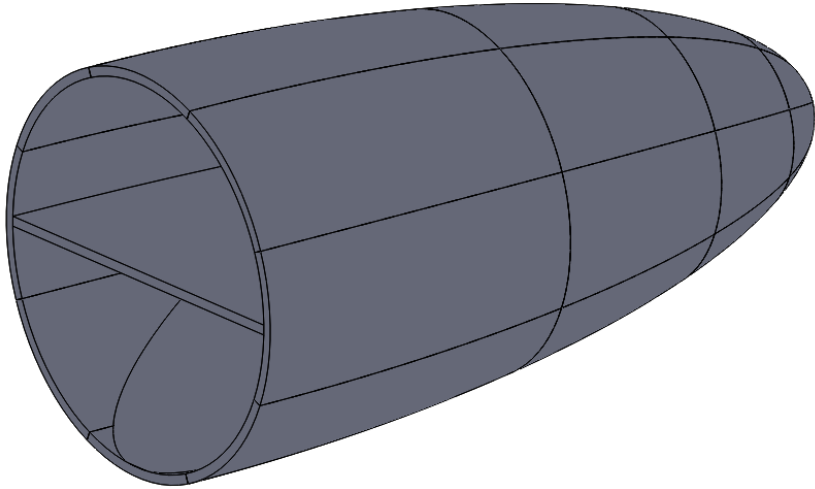

- Avoid overlapping of solids.
- Dividing curved net to small roughly flat solids (36 solids).
- Manually introducing the principal directions and porous media resistance coefficients.
- Defining thickness of the porous zones.

Surface method

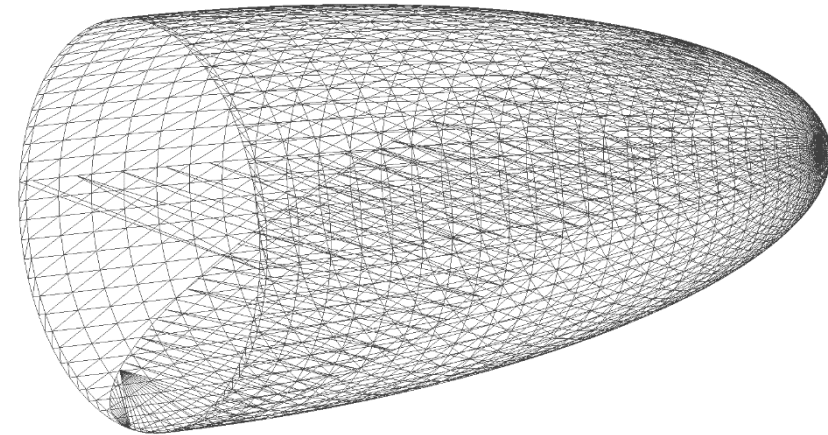

- The algorithm handles the cells according to the closest surface.
- The porous zones are created and managed using a user given grouping threshold angle.
- No need to manually provide principal directions of each porous zones. Only the porous resistance coefficients of each netting surfaces are needed.

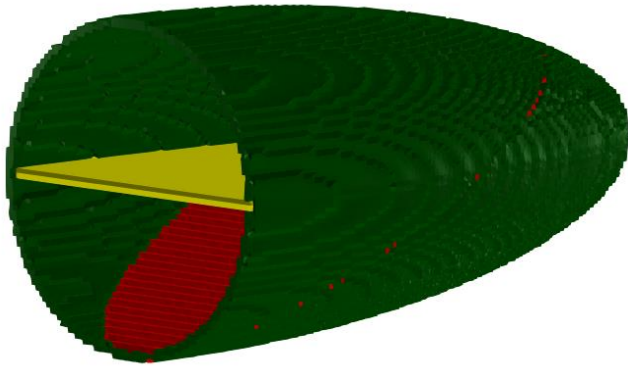

Body of influence of 3 surfaces

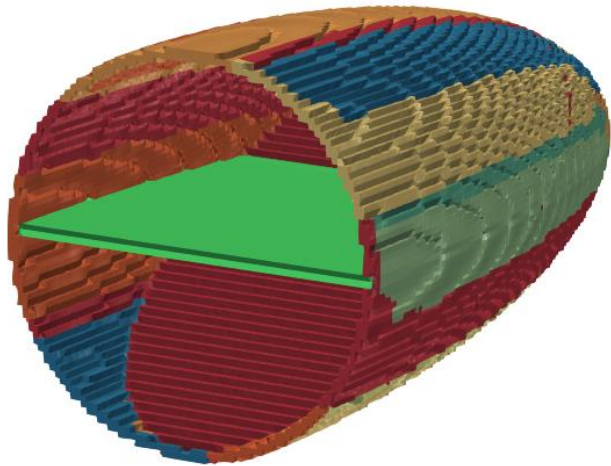

Porous zones generated with threshold angle 15°

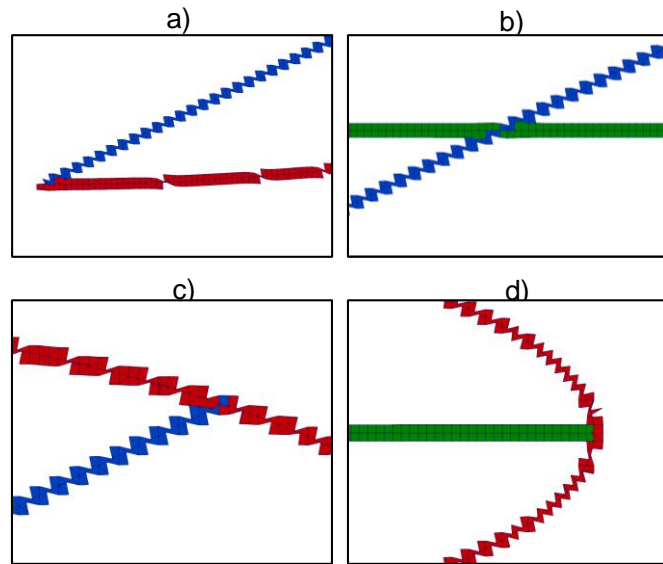
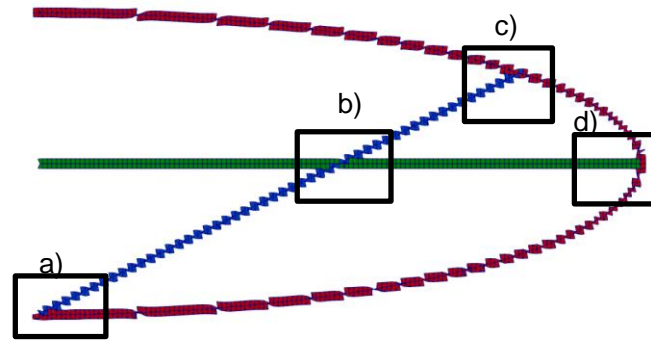

2D Section view at  $y = 0$

### Effect of number of porous zones

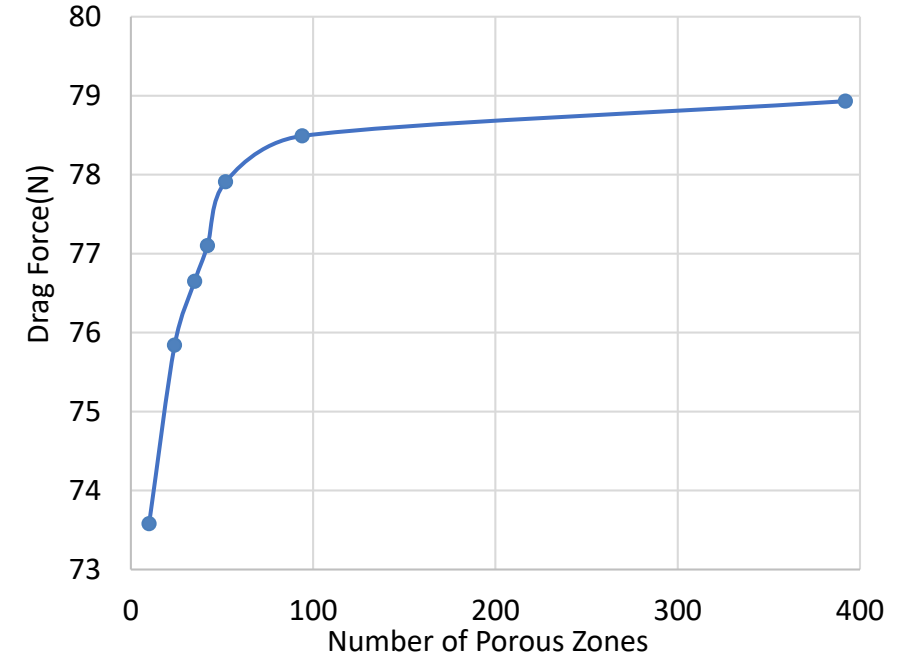

# 3.2 Example 2: Complex net geometry – comparison of velocity field

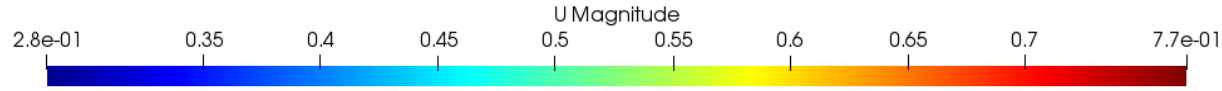

a)

b)

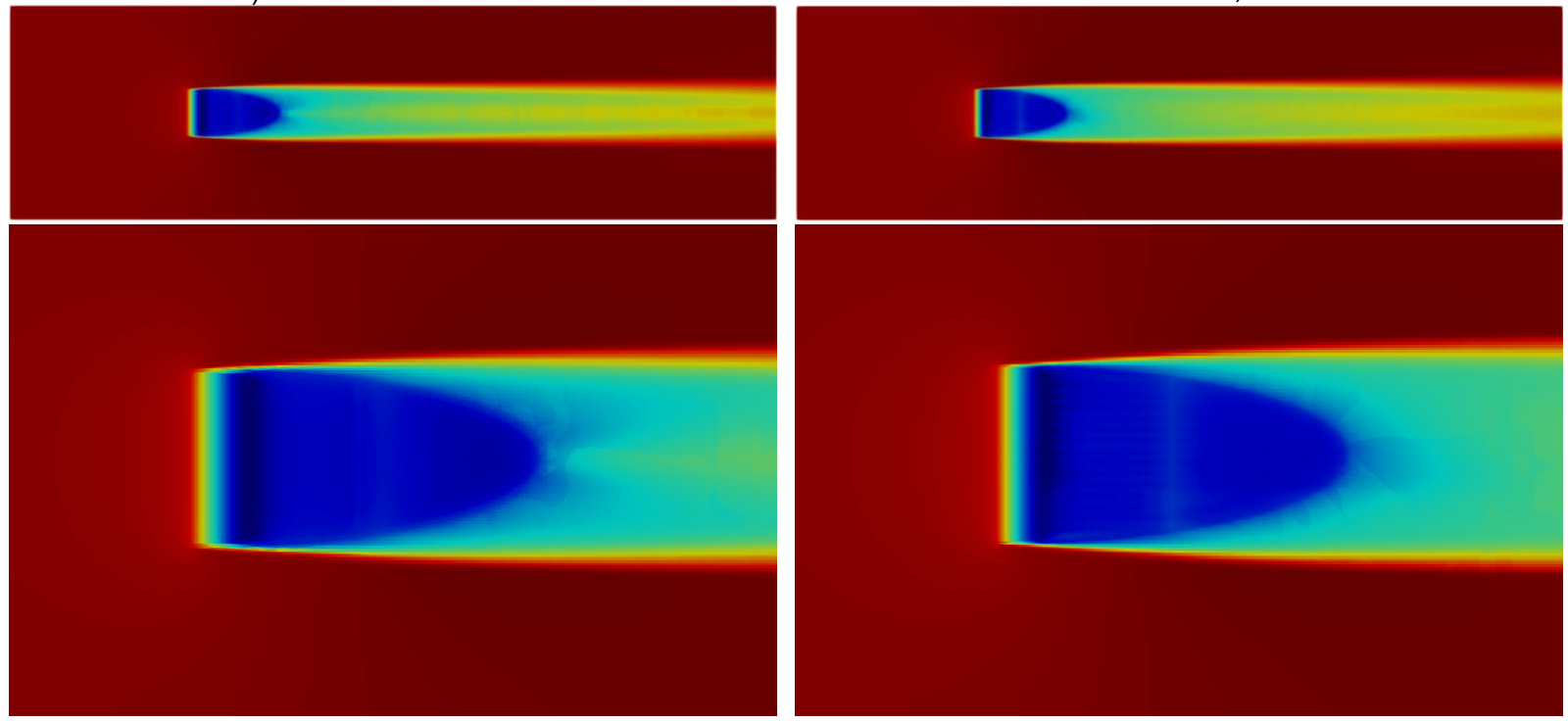

Thin solid method

Surface method

Magnitude of velocity plotted along the x axis

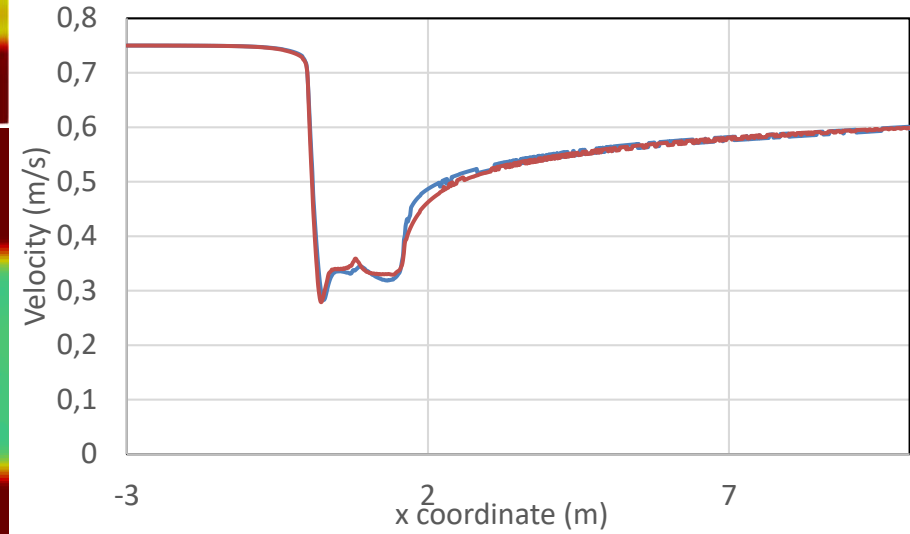



# 3.2 Example 2 : Complex net geometry – Comparison of pressure field

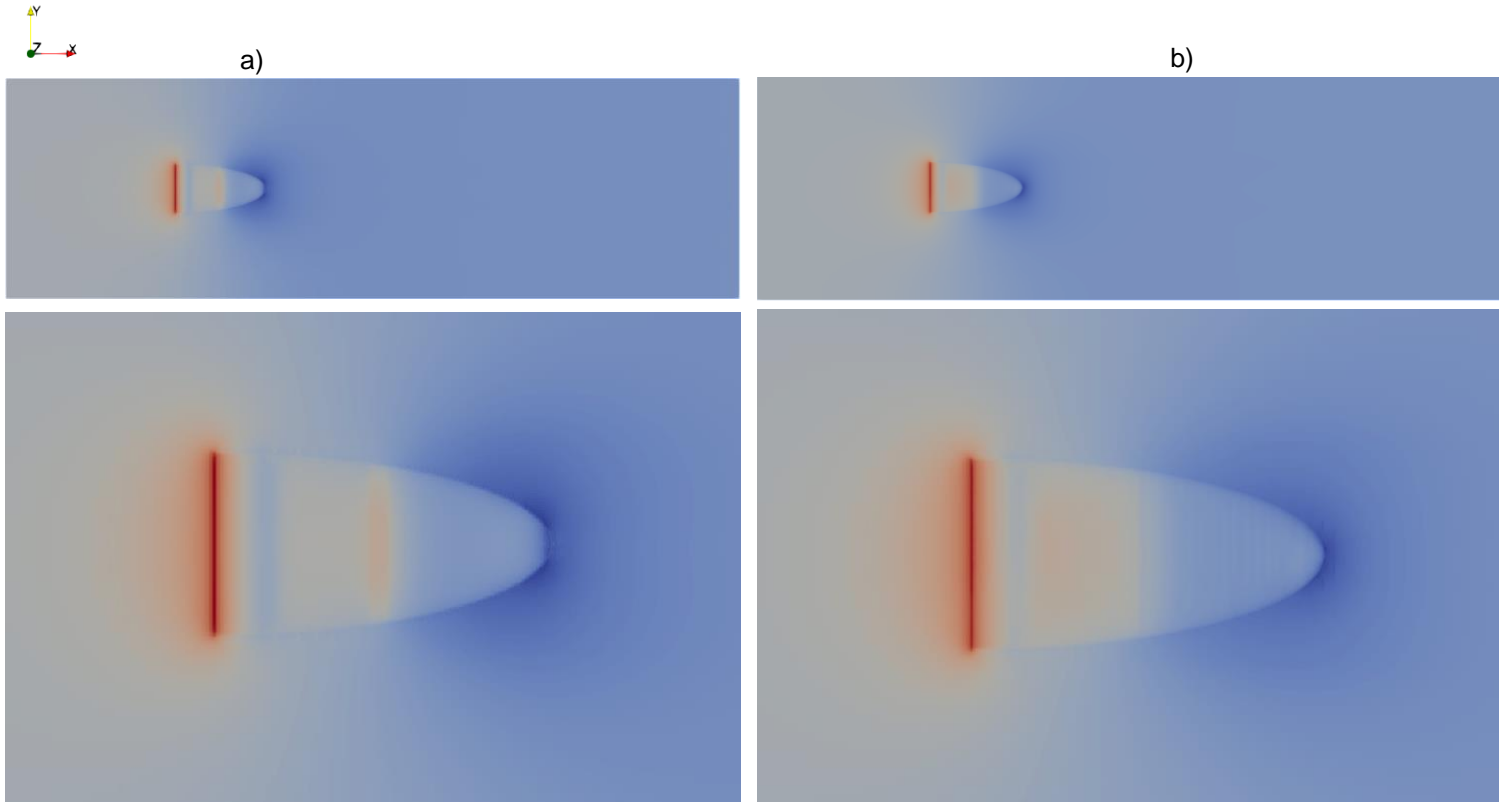
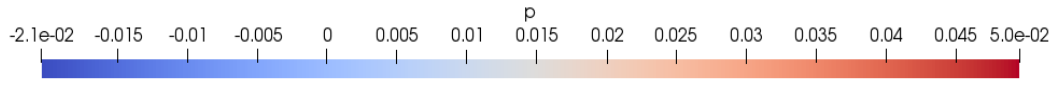

Thin solid method

Surface method

Pressure plotted along the x axis

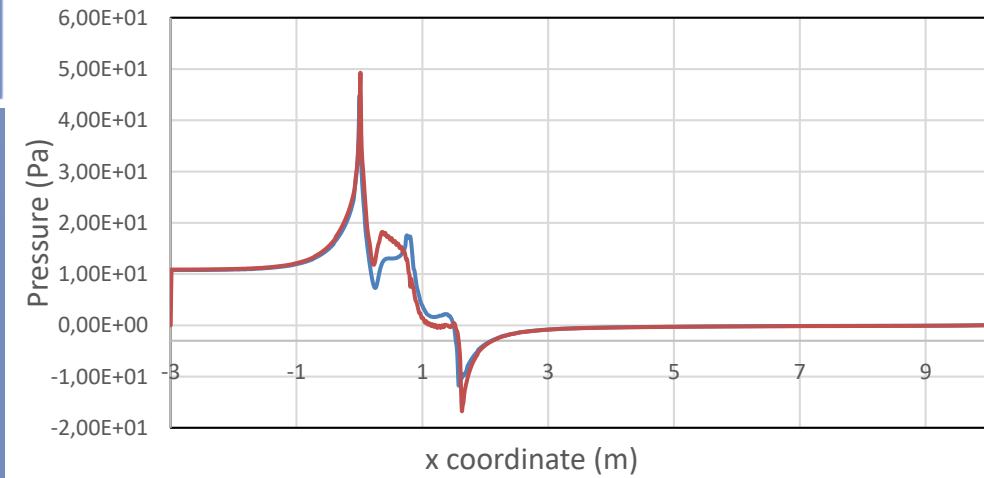

- Porous media approach: an efficient way to simulate fishing nets.
- Modelling net as surface: a surface based porous media model improves:
  - Modelling curved nets.
  - Modelling multiple nets with intersections.
  - Easier control over thickness of porous zones.
  - Easier control over size and number of porous zones.
  - Ability to deal with larger deflections.
  - A better communication with solid solvers for FSI Coupling.

### Introduction

- Porous media model requires coefficients for each type of netting.
- Existing ways to find porous media resistance coefficients include iterative CFD approaches ([Patursson et al, 2010](#)) and simplified analytical models ([Chen and Christensen, 2016](#)).
- Finding the differences of using Viscous ( $D_n, D_t$ ) and Inertial ( $C_n, C_t$ ) or only Inertial resistance coefficients.
- Using a 2D CFD model instead of analytical models.
- Comparison of results from existing approaches and finding the goodness of fit.

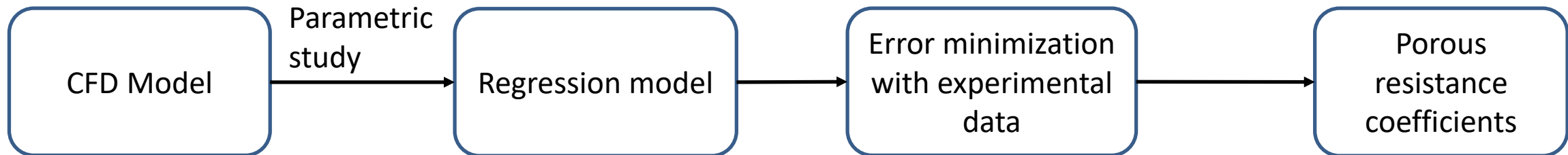

- A 2D CFD model with flow through a thin porous media layer.
- Based on flat net panel experiments.
- Parametric study over range of angles of attack, porous resistance coefficients, velocities.

$$S_i = - \left( D_{ij} \mu \mathbf{u} + C_{ij} \frac{1}{2} \rho |\mathbf{u}| \mathbf{u} \right)$$

$$D_{ij} = \begin{pmatrix} D_1 & 0 & 0 \\ 0 & D_2 & 0 \\ 0 & 0 & D_3 \end{pmatrix}, C_{ij} = \begin{pmatrix} C_1 & 0 & 0 \\ 0 & C_2 & 0 \\ 0 & 0 & C_3 \end{pmatrix}$$



$$D_{ij} = \begin{pmatrix} D_n & 0 & 0 \\ 0 & D_t & 0 \\ 0 & 0 & D_t \end{pmatrix}, C_{ij} = \begin{pmatrix} C_n & 0 & 0 \\ 0 & C_t & 0 \\ 0 & 0 & C_t \end{pmatrix}$$

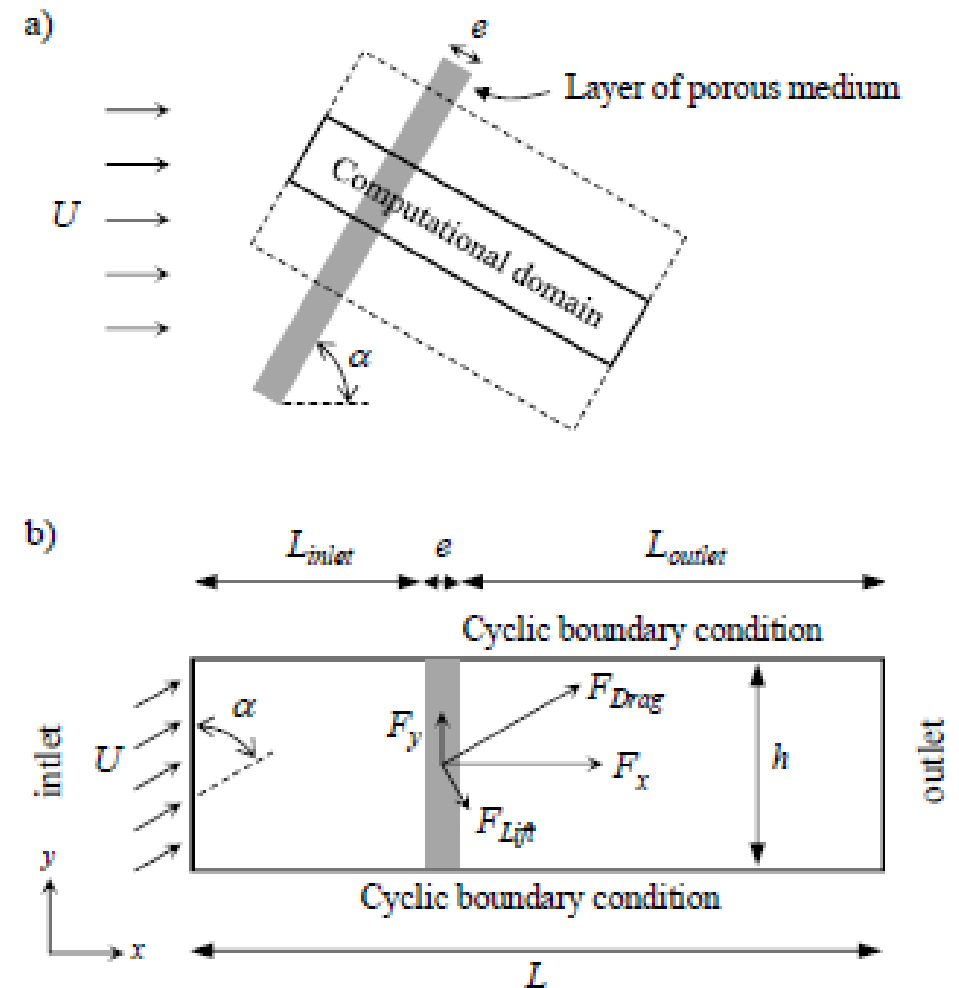

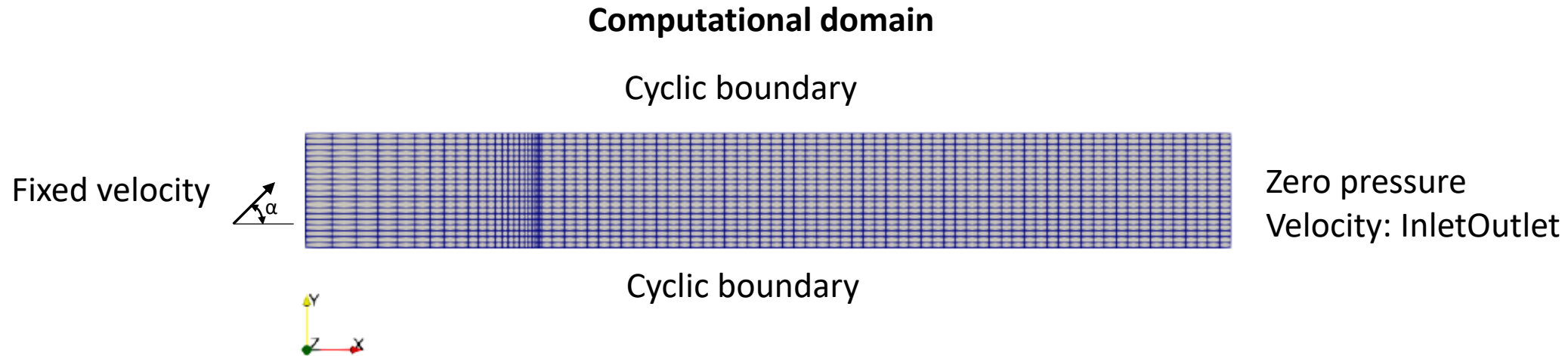

- Solver: porousSimplefoam – Incompressible, steady state solver used with implicit porous media implementation
- A structured mesh with 1660 cells.
- Realizable K-Epsilon turbulence model with initial turbulence intensity 1% and length scale of 0.15m

- A parametric study to pre-calculate  $C_D$  and  $C_L$  and for a range of physical parameters of the model.
- Results of the parametric study are interpolated (N-D Gridded spline) to build a regression model.

**Parameters used in the CFD Parametric study**

### Sub-study 1

$$C_D = C_D(\alpha, U, C_n, C_t)$$

$$C_L = C_L(\alpha, U, C_n, C_t)$$

### Sub-study 2

$$C_D = C_D(\alpha, U, C_n, C_t, D_n, D_t)$$

$$C_L = C_L(\alpha, U, C_n, C_t, D_n, D_t)$$

Parameter	Values	
$U$ (m/s)	0.25, 1.375, 2.5	
$\alpha$ (°)	15, 30, 45, 60, 75, 90	
$C_n$ (m <sup>-1</sup> )	0.30, 15.15, 30.00	
$C_t$ (m <sup>-1</sup> )	0.10, 5.05, 10.00	
	Sub-study 1	Sub-study 2
$D_n$ (m <sup>-2</sup> )	0	$1.0 \times 10^4, 5.05 \times 10^5, 1.0 \times 10^6$
$D_t$ (m <sup>-2</sup> )	0	$2.5 \times 10^3, 1.2625 \times 10^5, 2.5 \times 10^5$
Size	162	1458

# 4.2 Parametric study and regression analysis – Result Sub-study 1

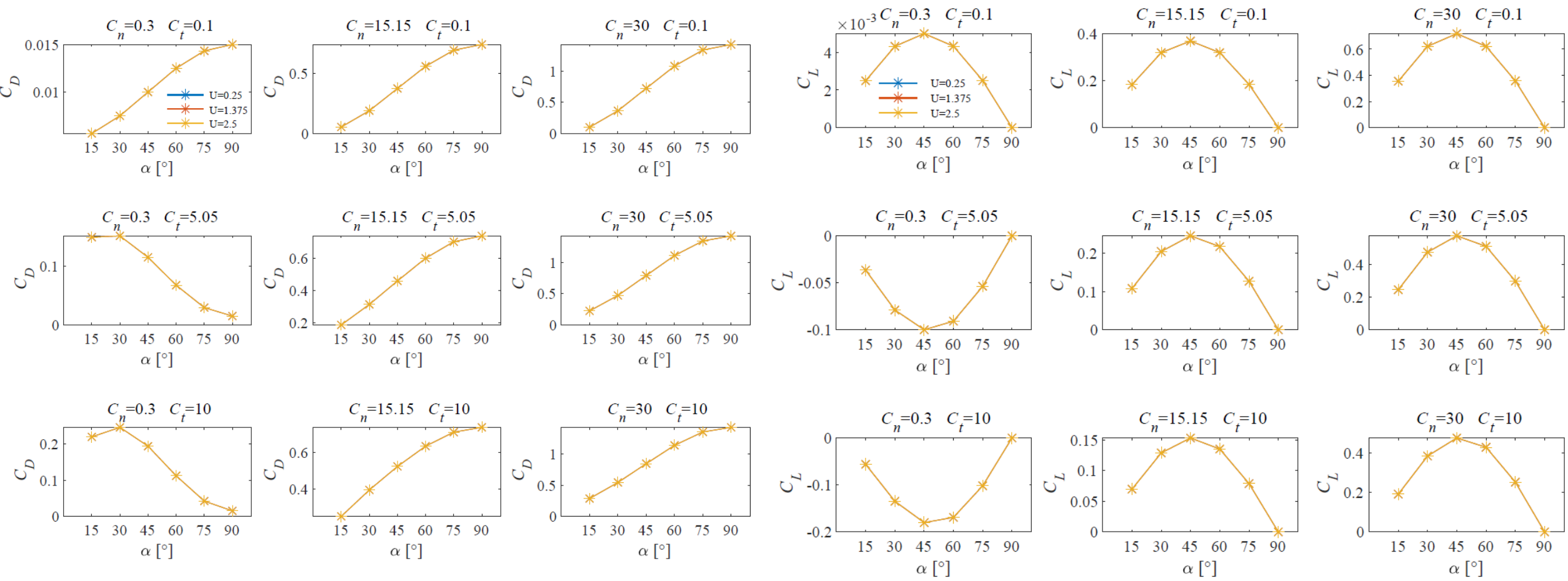

Coefficient of Drag

Coefficient of Lift

# 4.2 Parametric study and regression analysis – Result Sub-study 2

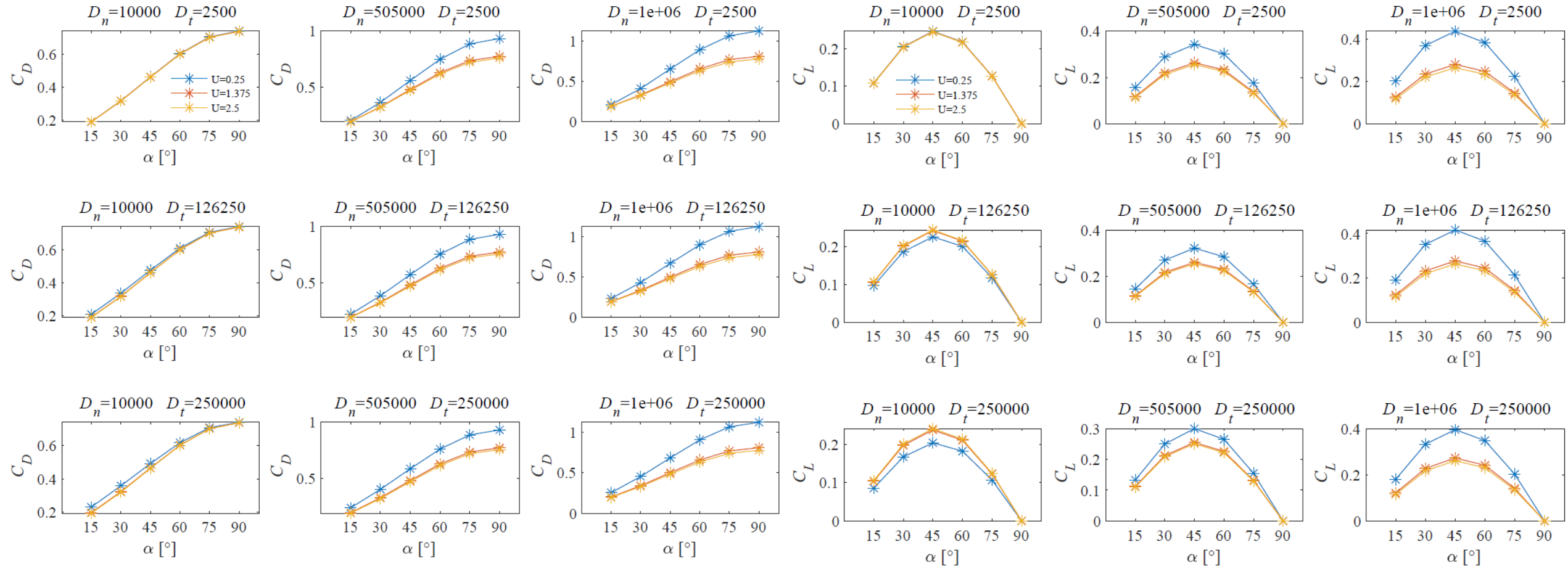

Coefficient of Drag

Coefficient of Lift



# 4.2 Parametric study and regression analysis – As function of resistance coeffs.

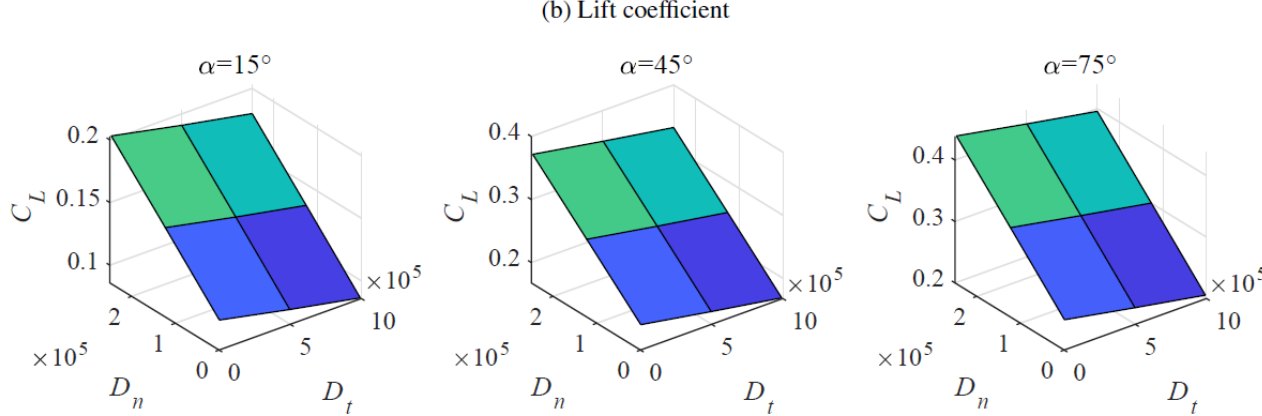
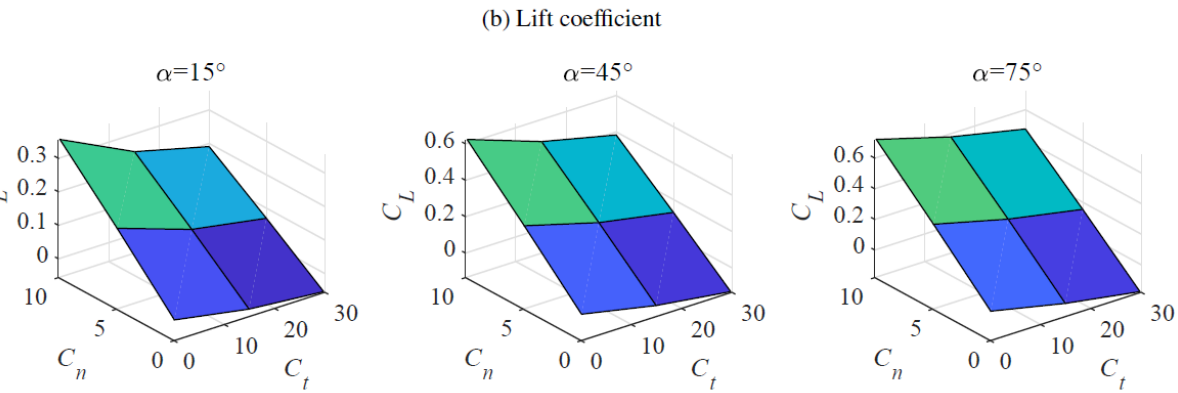
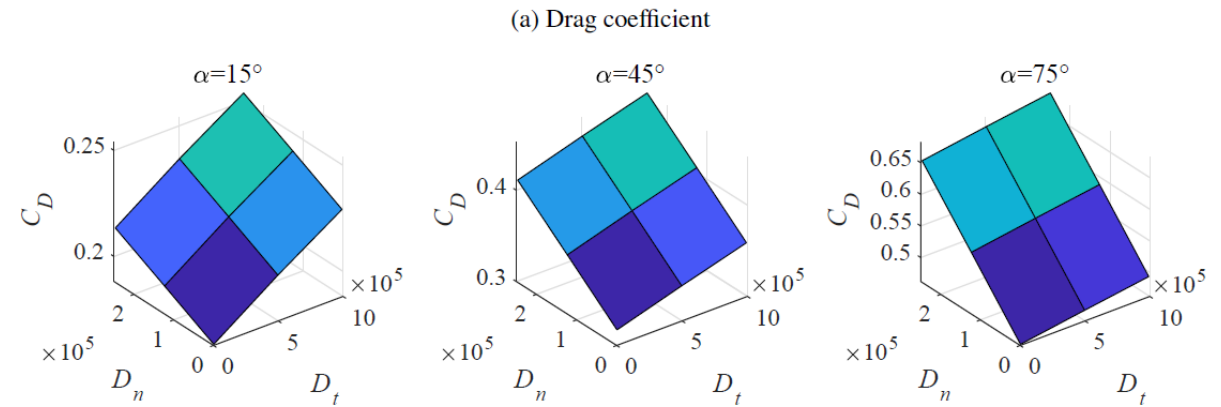
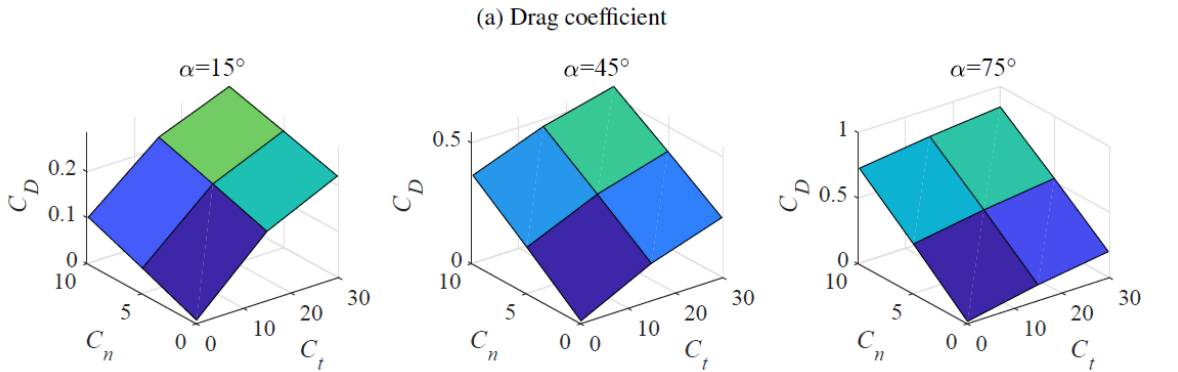

Sub-study 1

Sub-study 2

### Error functions used :

$$LANE = \frac{1}{N} \sum \left| \frac{C_D - C_D^{measured}}{C_D} \right| + \frac{1}{M} \sum \left| \frac{C_L - C_L^{measured}}{C_L} \right|$$

$$LSNE = \frac{1}{N} \sum \left( \frac{C_D - C_D^{measured}}{C_D} \right)^2 + \frac{1}{M} \sum \left( \frac{C_L - C_L^{measured}}{C_L} \right)^2$$

$$MAE = \frac{1}{N} \sum (|C_D - C_D^{measured}|)^2 + \frac{1}{M} \sum (|C_L - C_L^{measured}|)^2$$

**Nelder-Mead Simplex algorithm** for the multivariate minimization problem

### Goodness of fitting

- Coefficient of determination **R<sup>2</sup>** for measuring goodness of fit

$$R^2 = 1 - \frac{SS_{res}}{SS_{tot}}$$

$$\bar{R}^2 = 1 - (1 - R^2) \frac{n - 1}{n - p}$$

Example 1 : On the experimental study by Patursson et al (2010)

Method	$C_n$	$C_t$	$D_n$	$D_t$	$\bar{R}_D^2$	$\bar{R}_L^2$
Sub-study 1						
LSNE	5.527	1.908	0	0	0.948	0.925
LANE	5.412	1.828	0	0	0.956	0.924
MAE	5.268	1.761	0	0	0.953	0.919
Chen						
	5.32	1.71	0	0	0.955	0.924
Sub-study 2						
LSNE	4.085	0.917	195032	124953	0.975	0.935
LANE	4.645	1.088	100121	89213	0.980	0.921
MAE	4.470	1.084	121763	91414	0.981	0.926
Patursson						
LSNE	4.842	1.444	75854	35409	0.971	0.928
LAE	5.073	1.130	76486	84741	0.963	0.901
LANE	5.098	1.698	51730	26379	0.964	0.925

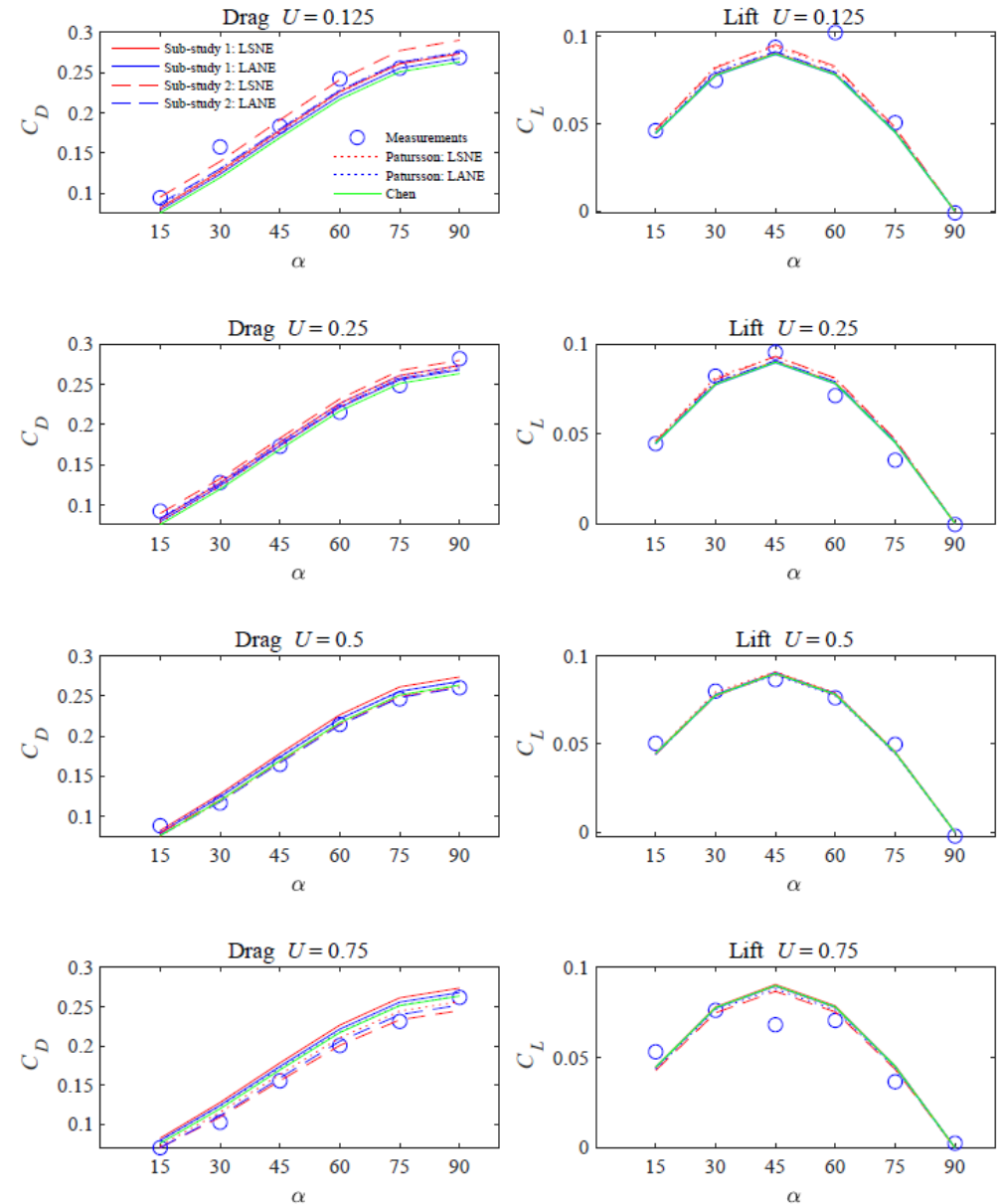

# 4.4 Results

Example 2: Experimental results from Rudi et al (1988)

Solidity : 0.13

Method	$C_n$	$C_t$	$D_n$	$D_t$	$\bar{R}_D^2$	$\bar{R}_L^2$
Sub-study 1						
LSNE	3.726	2.121	0	0	0.826	0.864
LANE	3.610	2.099	0	0	0.787	0.873
MAE	3.679	1.928	0	0	0.834	0.826
Sub-study 2						
LSNE	2.656	1.822	156123	45927	0.861	0.918
LANE	3.263	1.866	46912	27049	0.793	0.875
MAE	3.339	1.629	71009	65443	0.891	0.802
Patursson [1]						
LANE	3.302	1.993	112250	34352	0.862	0.802

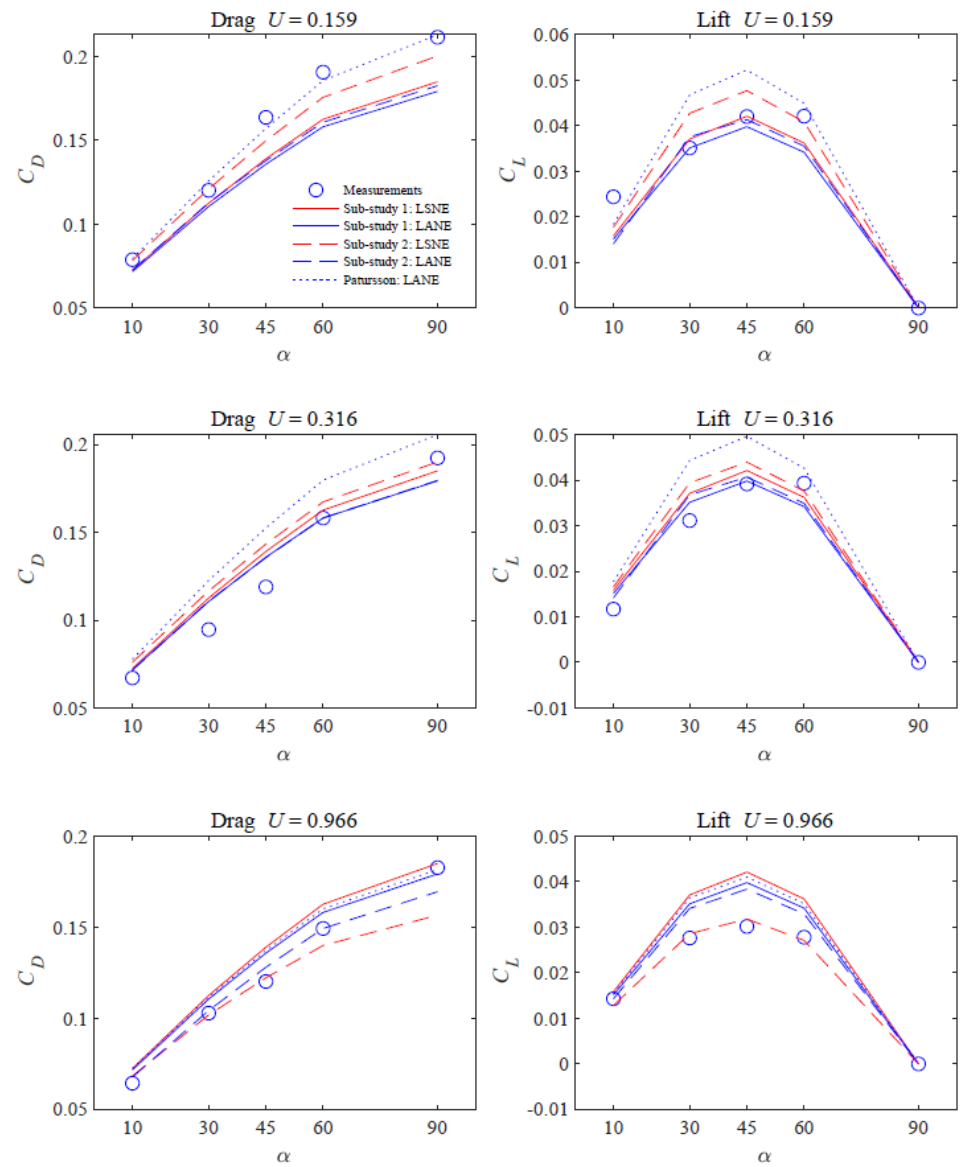

Example 2: Experimental results from Rudi et al (1988)

Solidity : 0.243

Method	$C_n$	$C_t$	$D_n$	$D_t$	$\bar{R}_D^2$	$\bar{R}_L^2$
Sub-study 1						
LSNE	6.117	2.694	0	0	0.910	0.932
LANE	6.128	2.554	0	0	0.916	0.913
MAE	6.130	2.552	0	0	0.916	0.913
Sub-study 2						
LSNE	5.035	2.592	158745	19542	0.923	0.963
LANE	5.236	2.952	134645	-14120	0.922	0.971
MAE	5.420	3.067	120872	-66758	0.946	0.919
Patursson						
LANE	6.149	2.815	152760	37283	0.870	0.790

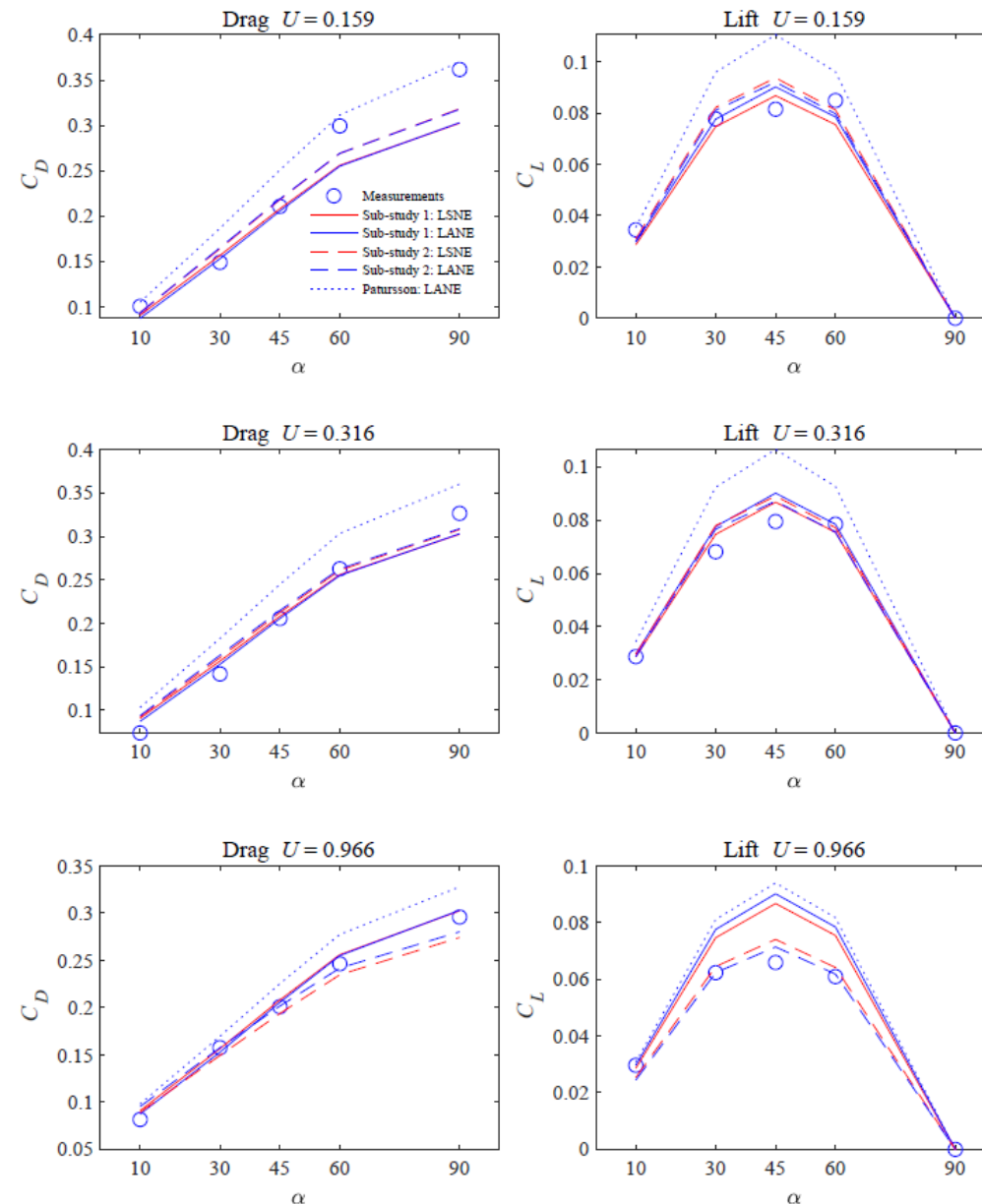

Example 2: Experimental results from Rudi et al (1988)

Solidity : 0.317

Method	$C_n$	$C_t$	$D_n$	$D_t$	$\bar{R}_D^2$	$\bar{R}_L^2$
Sub-study 1						
LSNE	13.585	5.380	0	0	0.736	0.788
LANE	13.322	5.036	0	0	0.714	0.784
MAE	13.641	4.875	0	0	0.754	0.759
Sub-study 2						
LSNE	9.174	6.481	590140	-102079	0.776	0.917
LANE	9.175	7.303	630939	-187126	0.813	0.906
MAE	9.676	7.378	662756	-208439	0.879	0.853
Patursson						
LANE	12.401	6.574	845370	105900	0.736	0.584

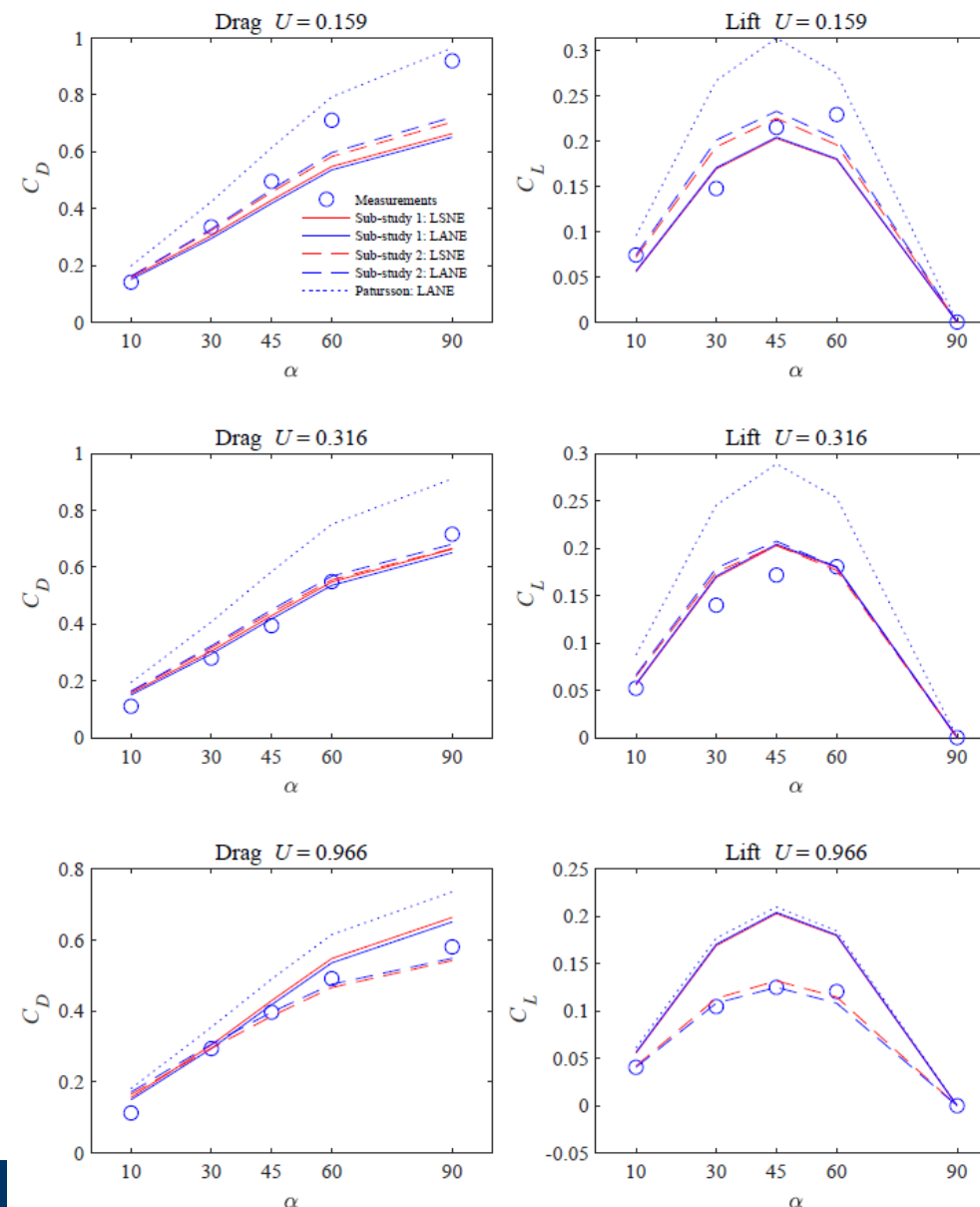

## Example 3 : Experimental results from Zhan et al (2006)

Solidity : 0.215

Method	$C_n$	$C_t$	$D_n$	$D_t$	$\bar{R}_D^2$	$\bar{R}_L^2$
Sub-study 1						
LSNE	6.959	1.709	0	0	0.821	-
LANE	6.301	2.016	0	0	0.694	-
MAE	6.329	1.919	0	0	0.712	-
Chen						
$U = 0.25$	9.860	3.030	0	0	0.364	-
$U = 0.5$	8.320	2.555	0	0	0.587	-
$U = 0.75$	7.400	2.275	0	0	0.748	-
$U = 1$	7.090	2.175	0	0	0.781	-
Sub-study 2						
LSNE	4.504	3.026	436981	-236726	0.934	-
LANE	5.922	2.036	120184	-42391	0.807	-
MAE	5.100	1.358	370128	80155	0.906	-

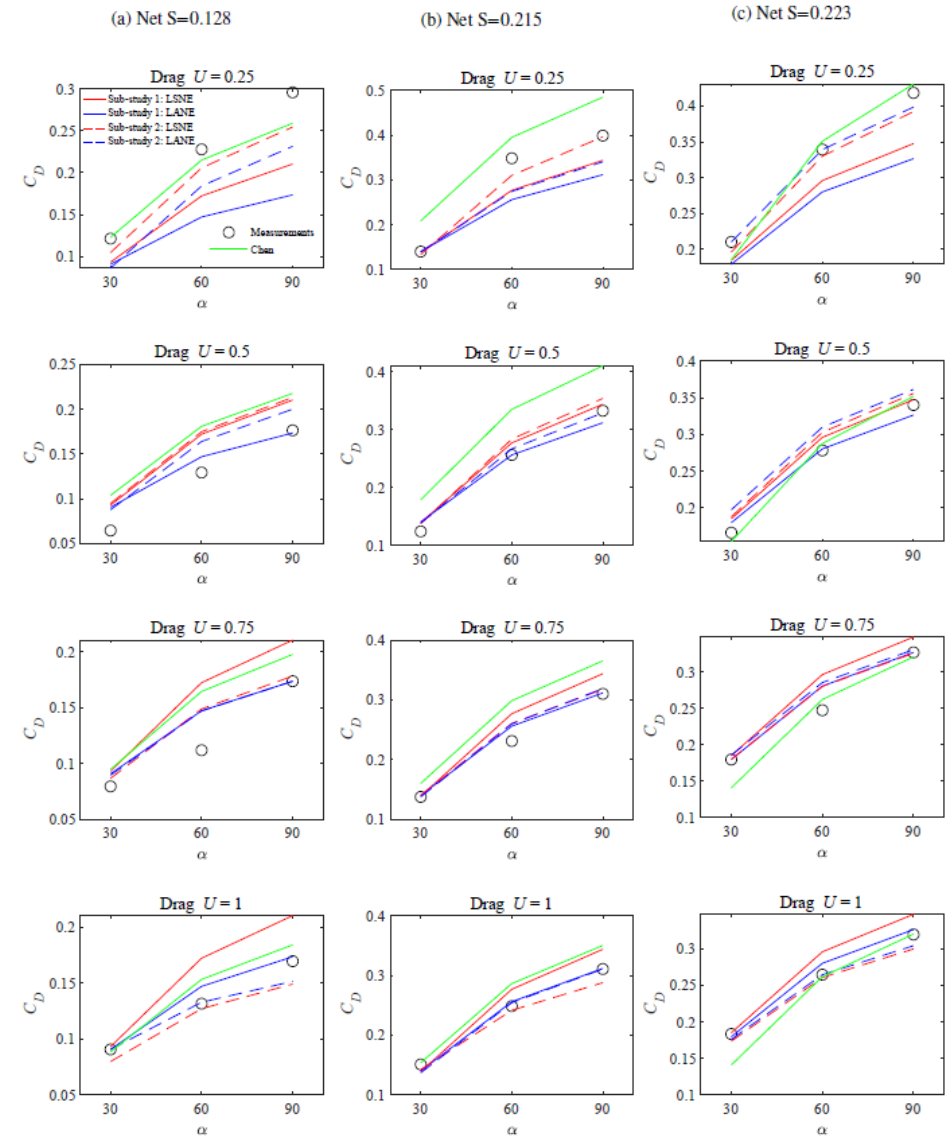

- Estimation of porous media resistance coefficients based on regression analysis and experimental data.
- Regression model based on a 2D CFD model.
- Can be applied to wide range of netting irrespective of the type of knots and twines.
- Case studies with both inertial and viscous coefficients and only inertial coefficients.
- Similar or better goodness of fitting than the existing methods.
- Choosing error function for experimental dataset : Rely on regression analysis for better results.



- Globally practised fishing technique responsible for 25% of total global wild catch.
- Fishing technique where the gear is towed close to the seabed to catch species living near the seabed.
- Famous for the large bycatch, environmental impact and huge fuel consumption.

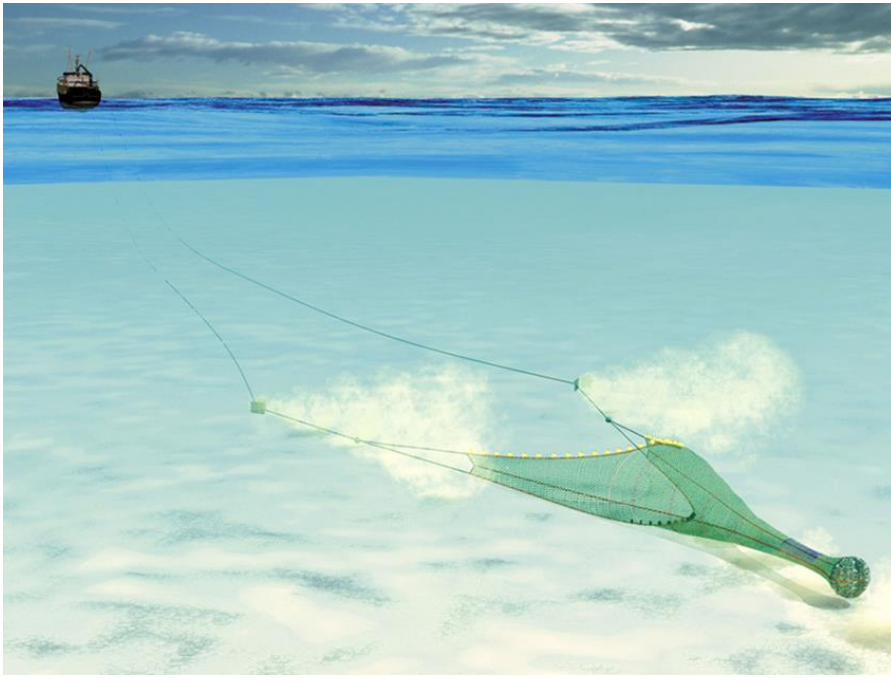

## Understanding seabed impact

- Sediment entrainment caused by fishing gears
- Need for understanding the impact caused by individual components.
- Fishing net and its dependence
- Methods to understand the impact of fishing nets on sediment mobilisation

- Solver: porousSimpleFoam (steady state solver for incompressible turbulent flow).
- Meshing: Structured and Unstructured mesh.
- Turbulence modelling: K-Omega SST model.

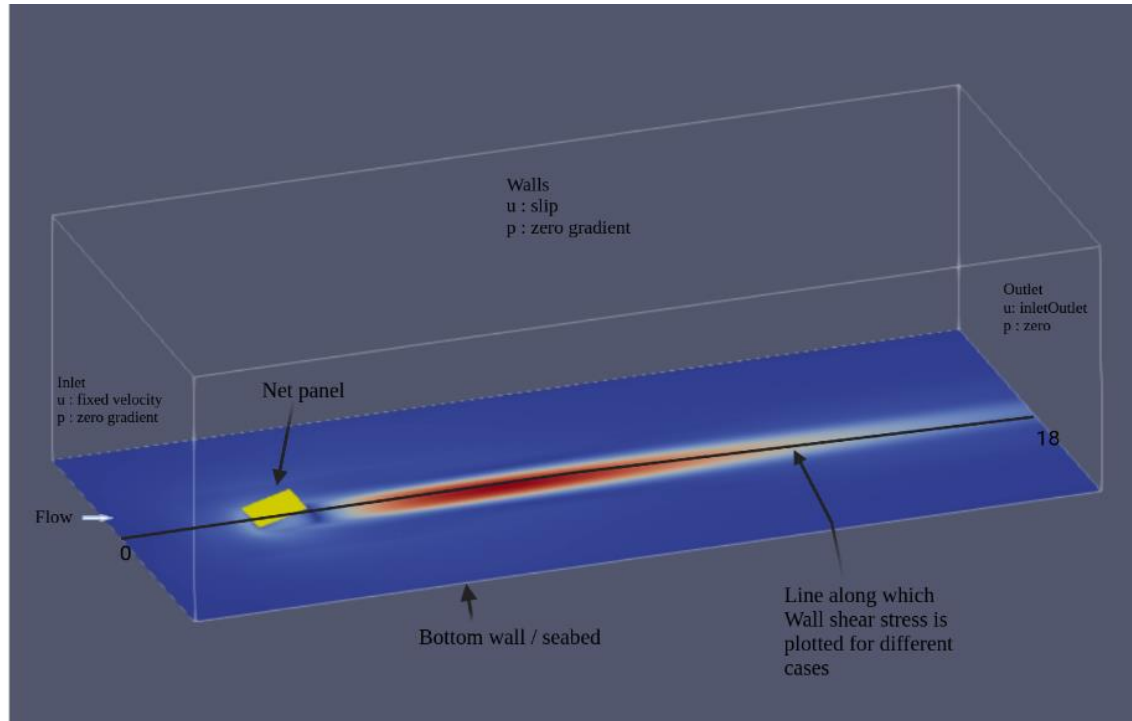

### Parameters studied:

- Velocity of trawling.
- Length of the netting panel.
- Angle made to the seabed.
- Distance from the seabed.
- Solidity ratio of the fishing nets.

Looking for the **wall shear stress** on the bottom wall and the **hydrodynamic forces** experienced due to netting.

# 5.2 Results - Distance above the seabed

A 1m x 1m net panel making 10° towed at 2 m/s

grain type	Diameter (μm)	$CSS_{Motion}$ (N/m <sup>2</sup> )	$CSS_{Suspension}$ (N/m <sup>2</sup> )
Fine Silt	20	0.075	0.075
Fine sand	300	0.2	0.3
Coarse sand	1000	0.5	1.5

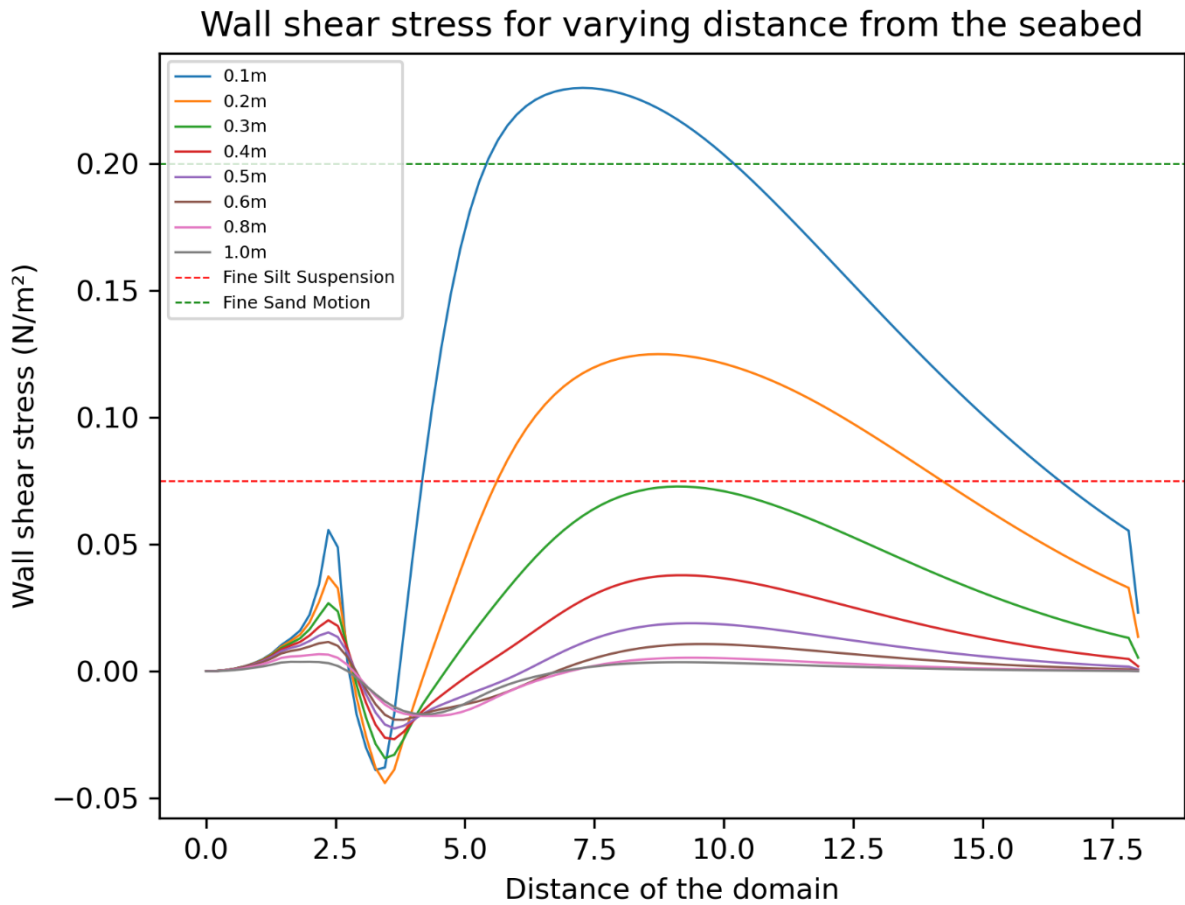

## Hydrodynamic coefficients

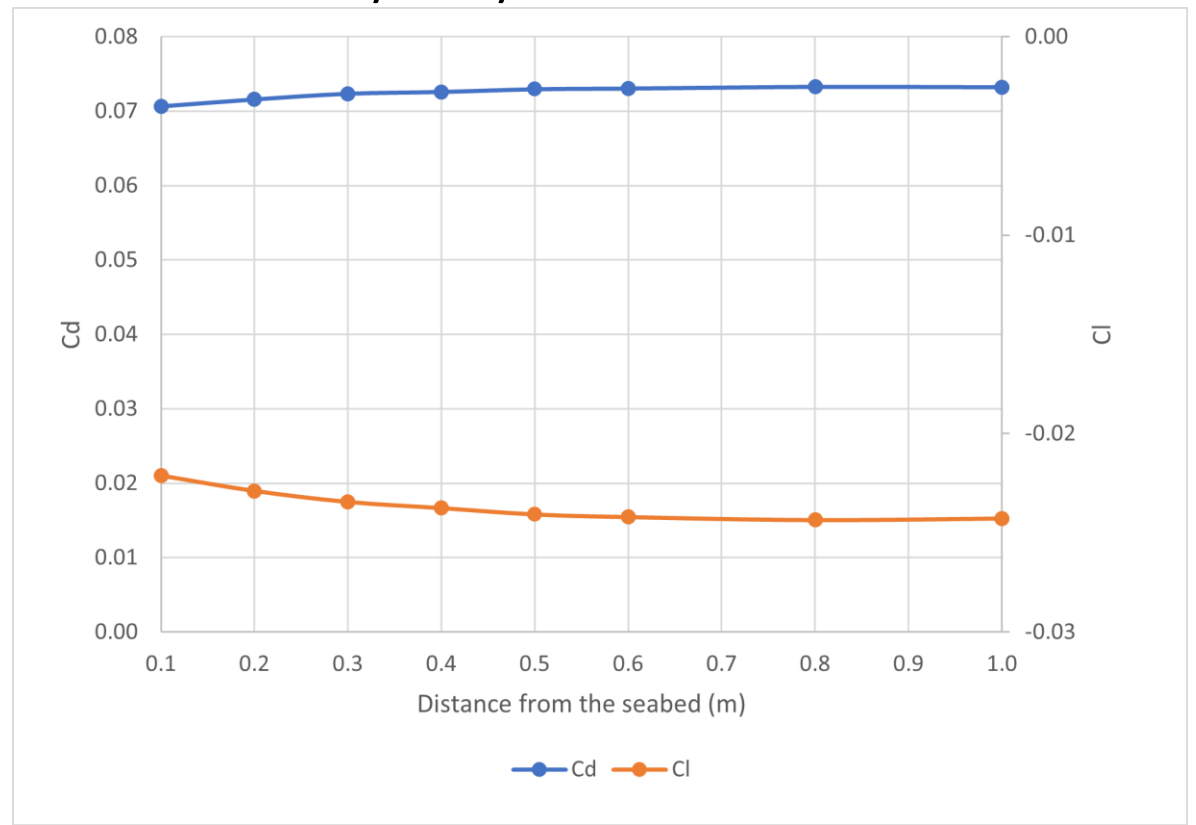

## 5.2 Results – Angle of attack made to the seabed

A **1m x 1m** net panel towed at **2 m/s** for varying angles of attack made to the seabed.

Distance from the seabed: **0.1m**

Wall shear stress for varying angles of attack

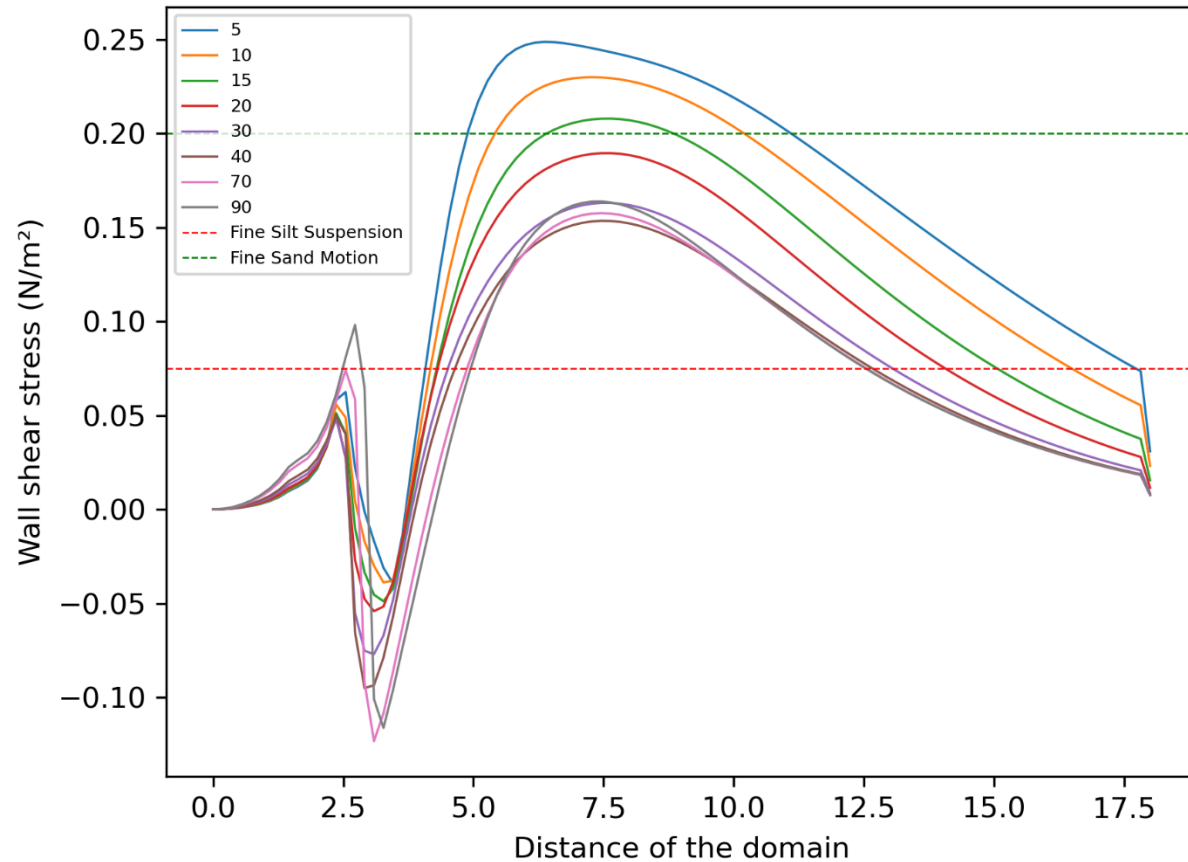

Hydrodynamic coefficients

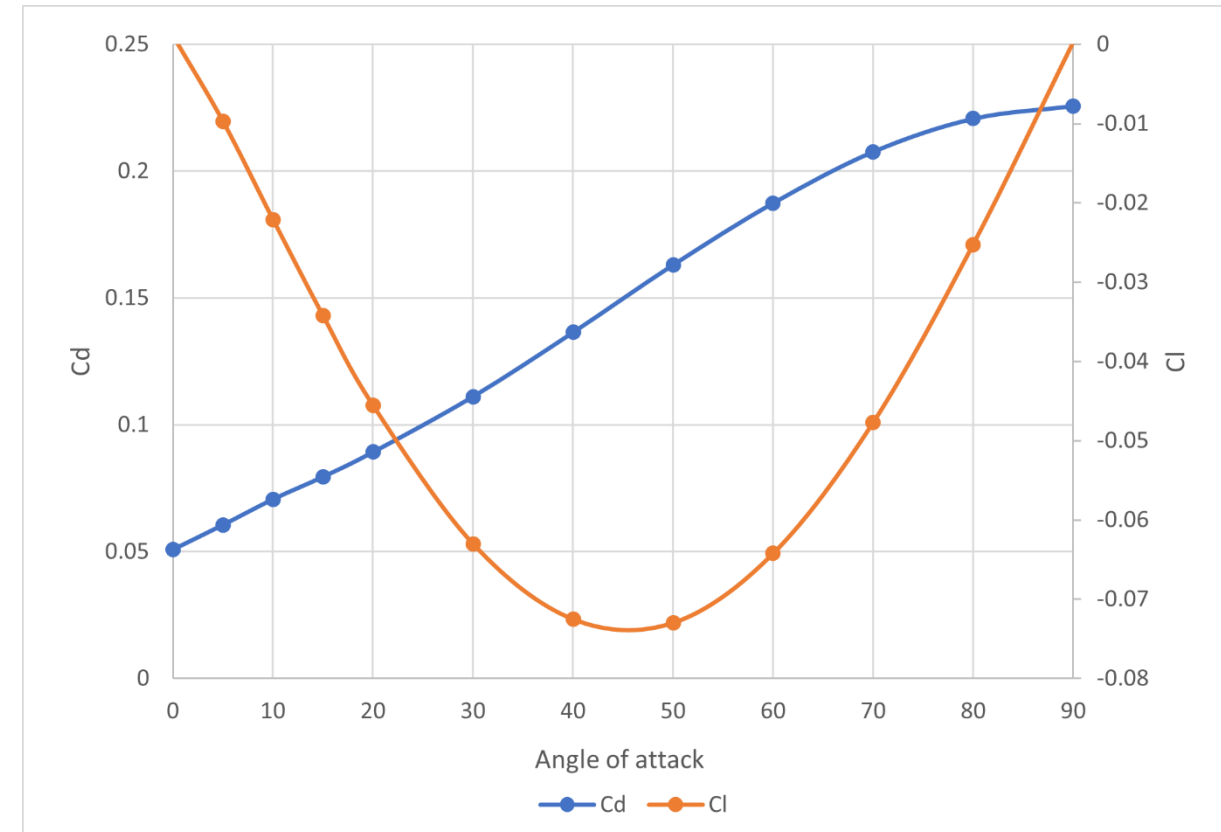

Two studies:

- 1: Keeping the **same angle of attack**, changing the length of the netting panel.
- 2: Keeping the **height** of the leading and trailing edge constant.

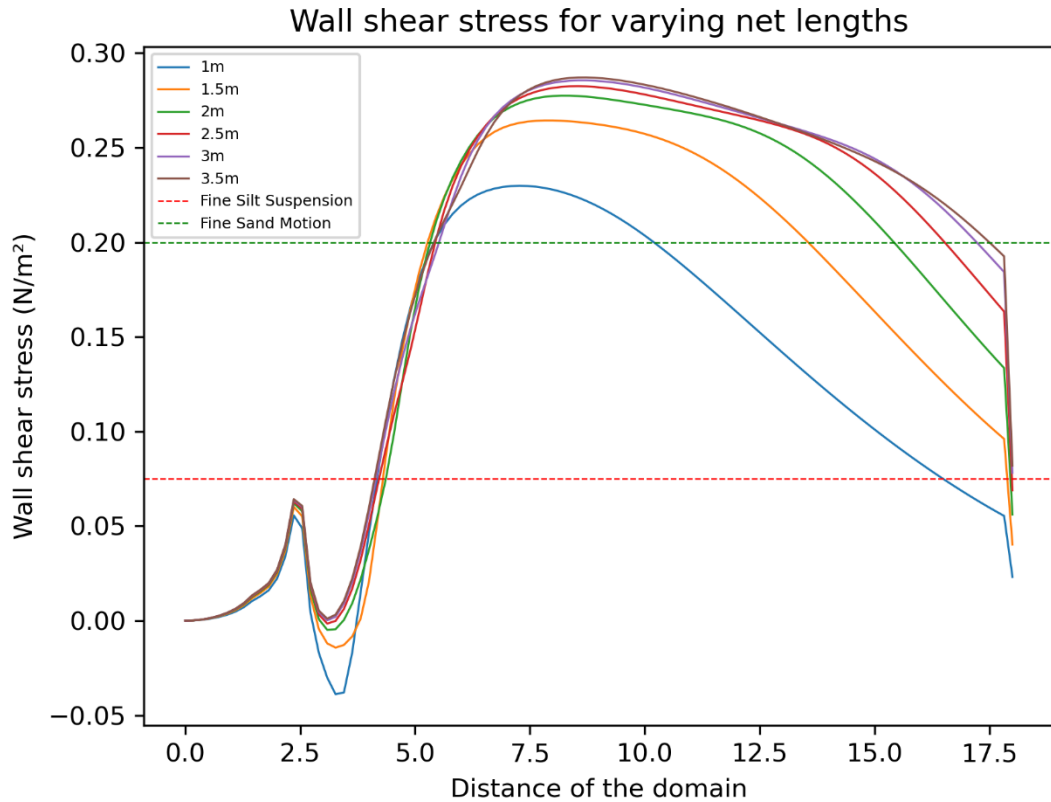

Sub-study 1

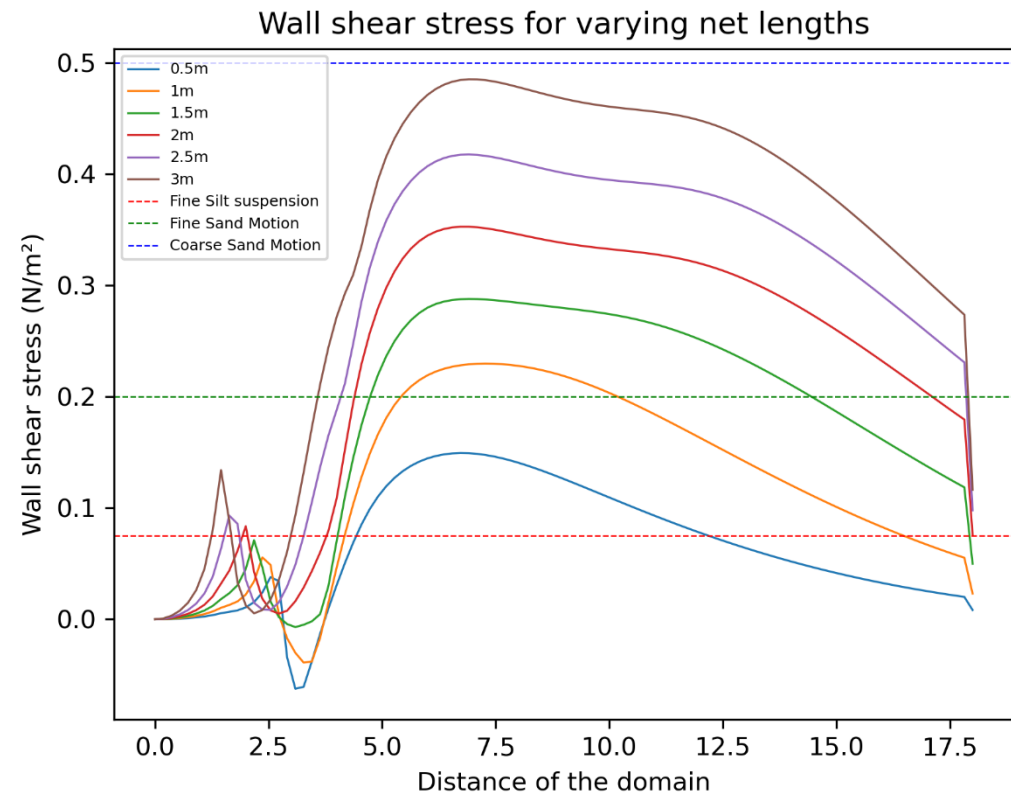

Sub-study 2

Two studies:

- 1: Keeping the **same angle of attack**, changing the length of the netting panel.
- 2: Keeping the **height** of the leading and trailing edge constant.

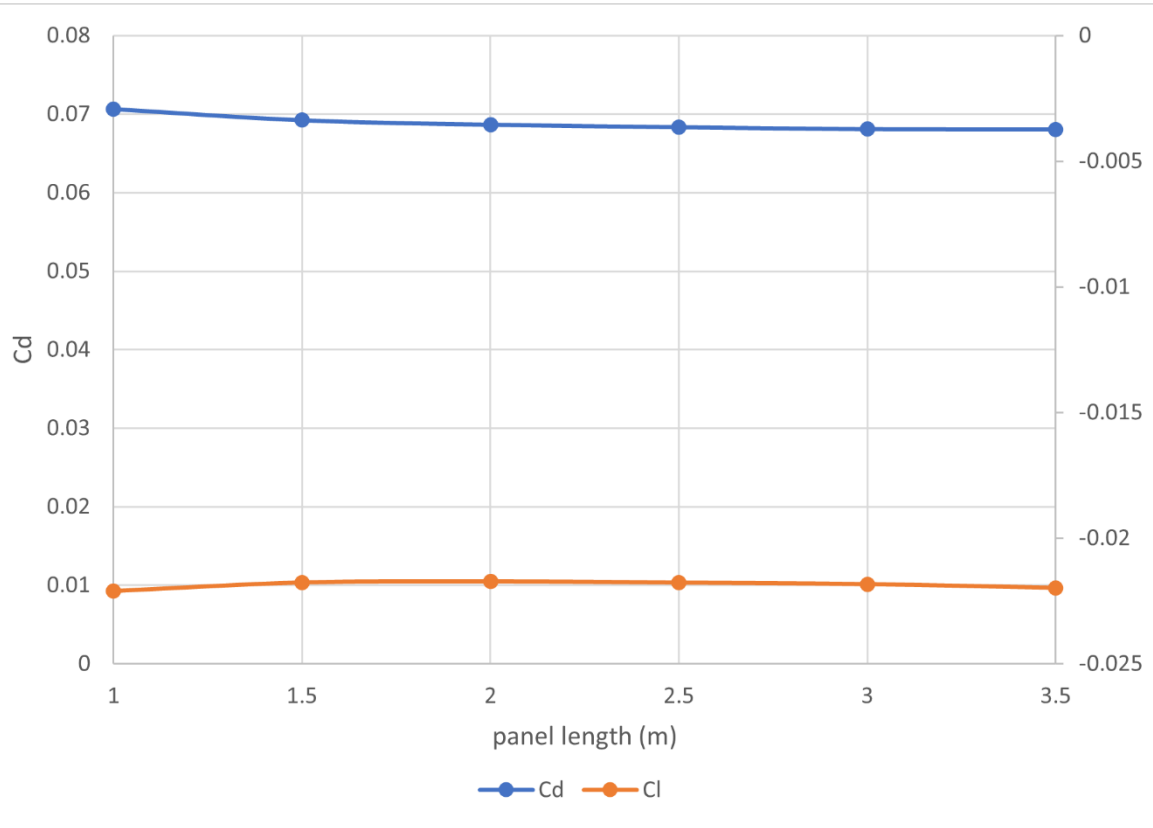

Sub-study 1: Hydrodynamic coefficients

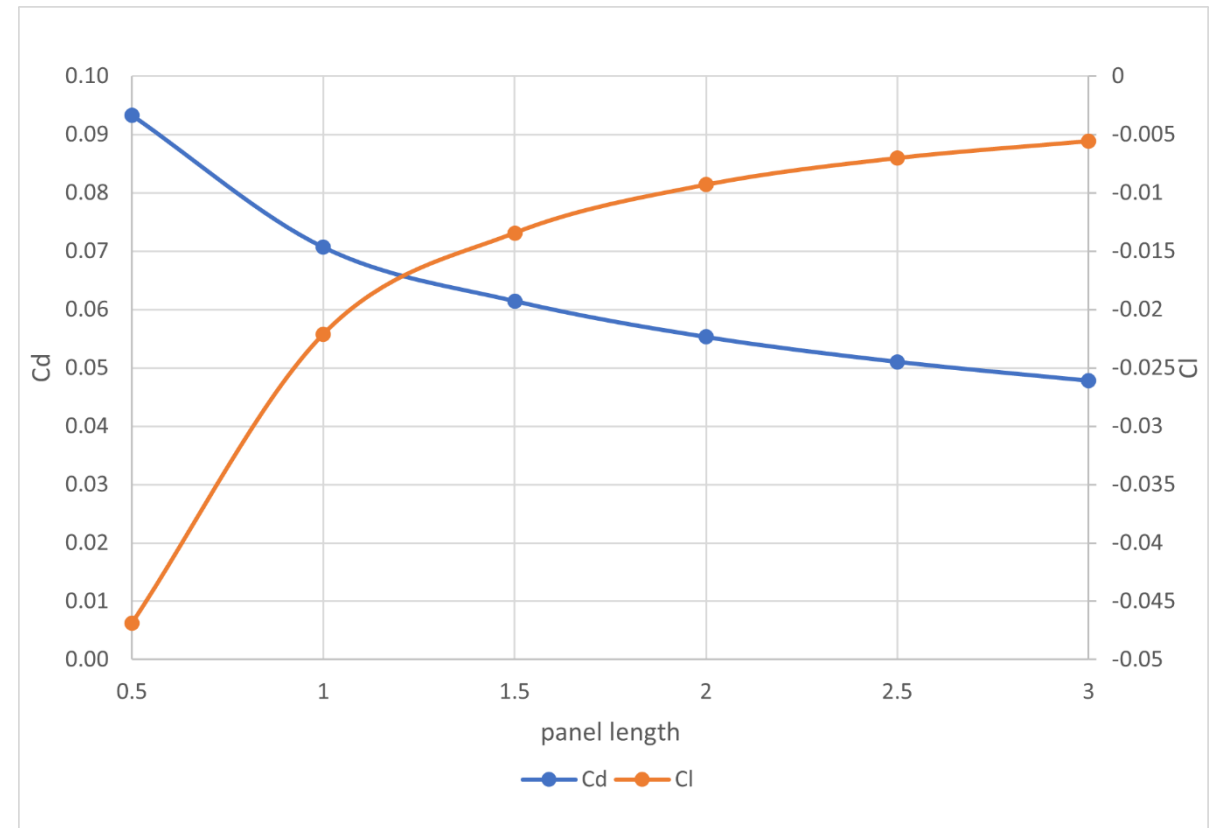

Sub-study 2: Hydrodynamic coefficients

## 5.2 Results – Netting solidity ratio

A way to characterize different type of nets is with **solidity ratio**

*Ratio of the projected area of the netting to the total area enclosed by the netting panel*

$$S_n = \frac{2d}{\lambda} - \left(\frac{d}{\lambda}\right)^2$$

Hydrodynamic coefficients

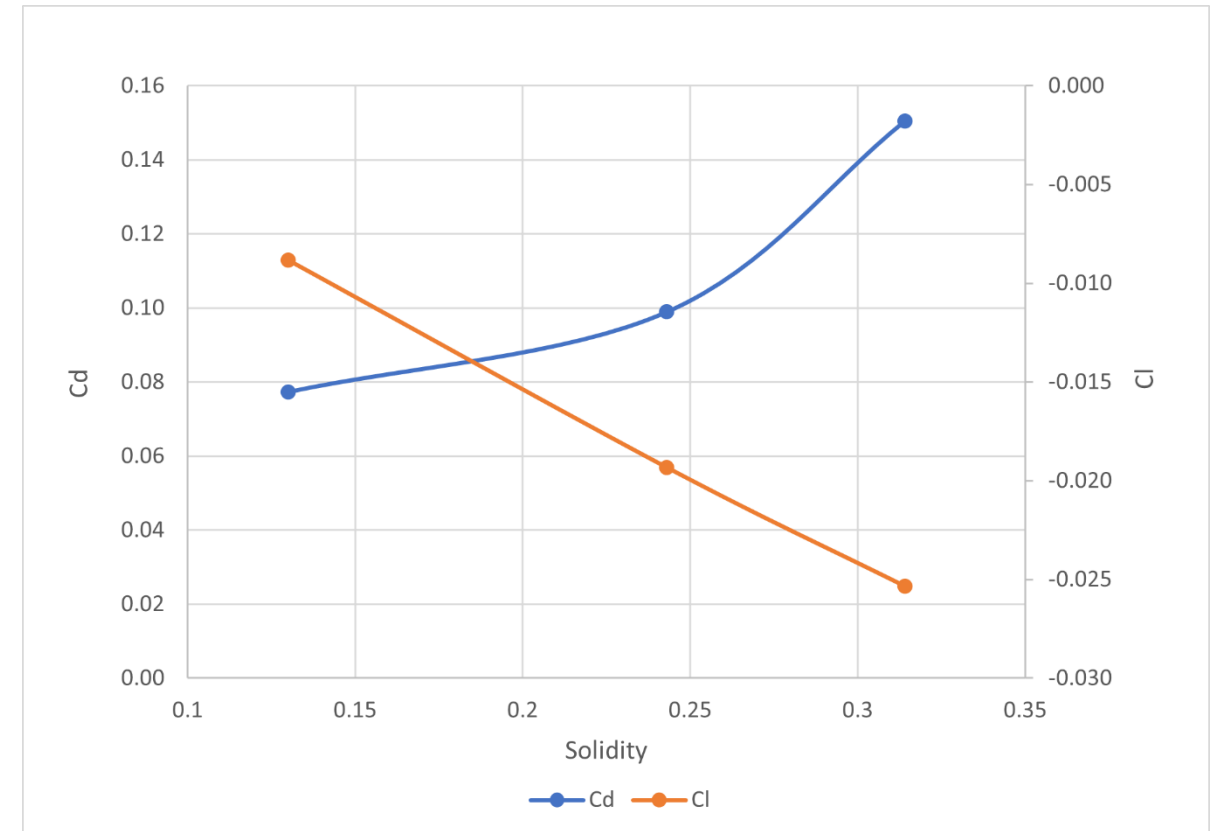
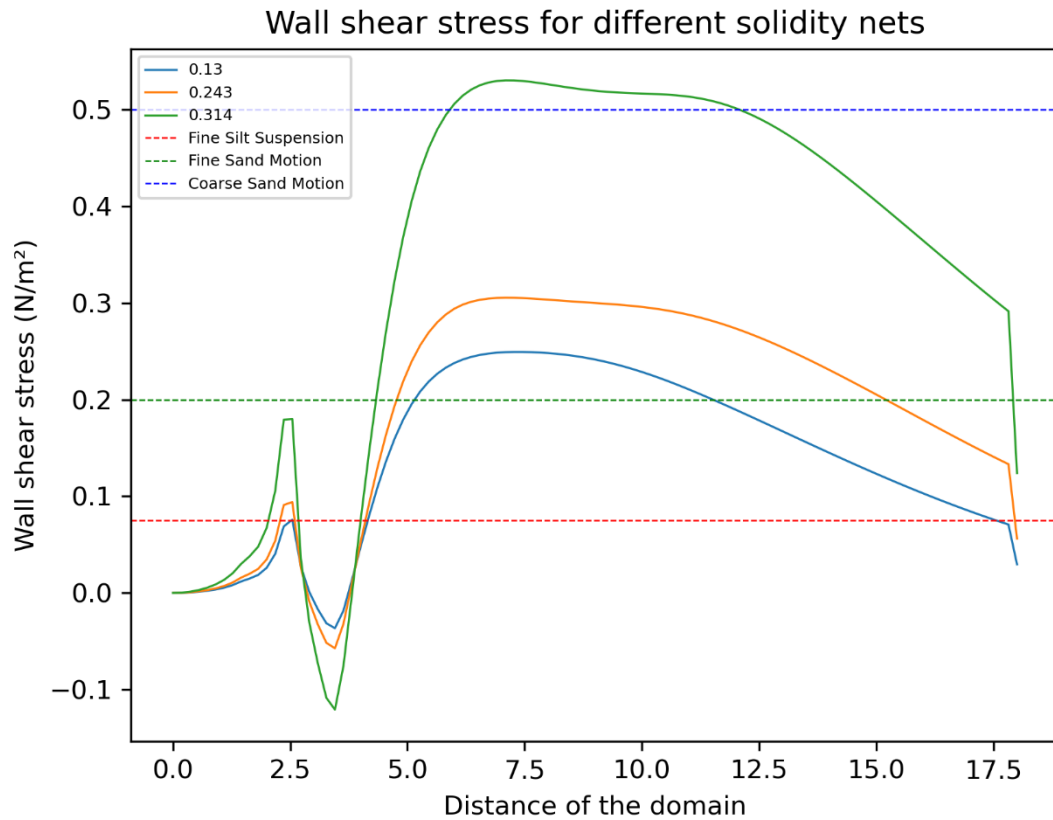

Wall shear stress for varying velocity

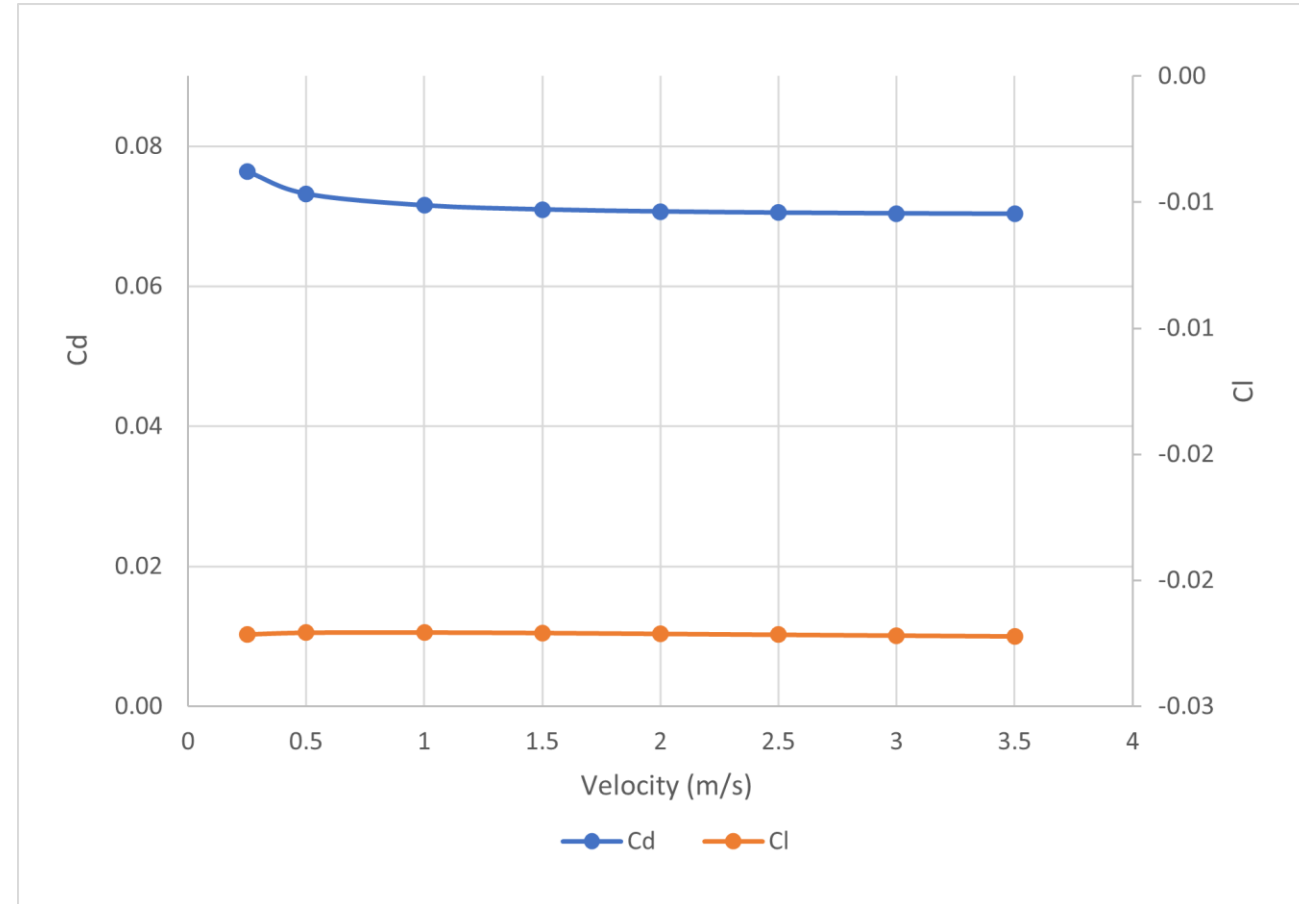
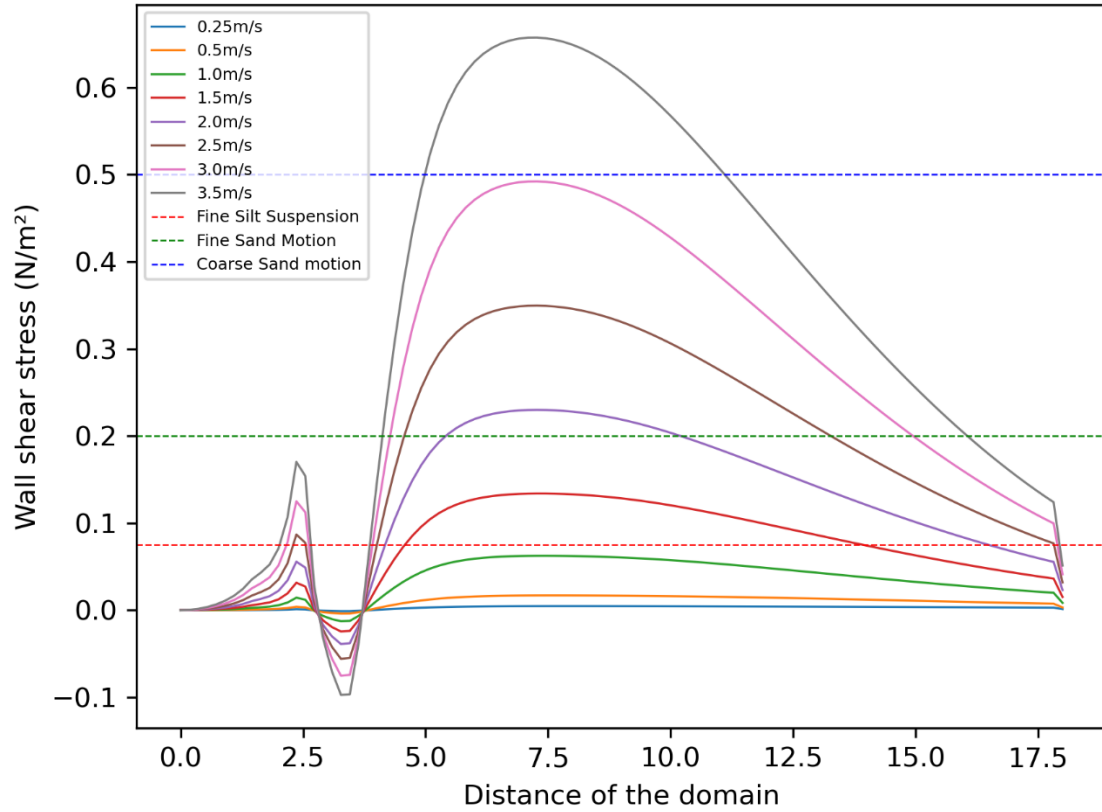



- Dependence of parameters on shear stress and hydrodynamic forces.
- Shear stress and the critical values to mobilise/initiate movements of sediments.
- CFD as a tool in order to understand the fisheries.
- Sediment transport while trawling and the effect of difference parameters.
- Future work: Investigations on turbulence intensities and wall modelling according to the sediment size.

## Conclusions

- Computational simulation of fishing nets for improving fishing gears.
- Porous media model for the fluid part of the simulation.
- Surface based porous media model.
- Computing porous media resistance coefficients using a full CFD model.
- Method applied to real life problems in fisheries : sediment transport caused by netting while demersal trawling.

## Future works

- Coupling to a solid solver for applying the model to flexible nets.
- Carrying out towing tank experiments for validating the coupled software.
- Experiments for finding efficiently the porous resistance coefficients at smaller angles of attack.

- S.Karumathil and M. González, “Simulation of fluid flow across net panels using a surface-based porous media model”, Under review : Ocean Engineering, Submitted on : 25-11-2022
- M.González and S.Karumathil, “A new method to estimate the resistance coefficients of net panels modelled as porous media” Under review: Ocean Engineering, Submitted on : 17-10-2022



Thanks for listening!